

PRE1278

Mitutoyo



Autumn Promotion

2024

Valid from November 1, 2024
until January 31, 2025



The New QuantuMike



U-WAVE fit

COOLANT PROOF™



IP65

DIGIMATIC S1

0-25 mm and 25-50 mm

+ For additional accessories and their compatibility, please find the table on page 42.

High Speed & High Accuracy

Faster measurement by using a coarser thread, which feeds the spindle by 2 mm per thimble rotation.

293-140-40

€ 380,00



Bidirectional Digimatic S1 interface.

In addition to outputting measurement data, it is also possible to perform operations such as setting and controlling the digimatic gauge itself and collecting individual information of digimatic gauges from the connected PC.

Ratchet thimble

Ratched thimble mechanism that allows stable measurement even when operated one-handed.

Ratchet speeder

Ratcheting microvibrations along the axis of measurement help ensure stable measurement.

High accuracy measurement of $J_{MPE} \pm 1 \mu m$

Range 0-25 mm and 0-50 mm





Also available:

293-141-40

€ 468,00

Range 25-50 mm



Also available:

293-142-40

€ 556,00

Range 50-75 mm



Also available:

293-143-40

€ 628,00

Range 75-100 mm

Reliable

Approach Speed Warning Function

NEW

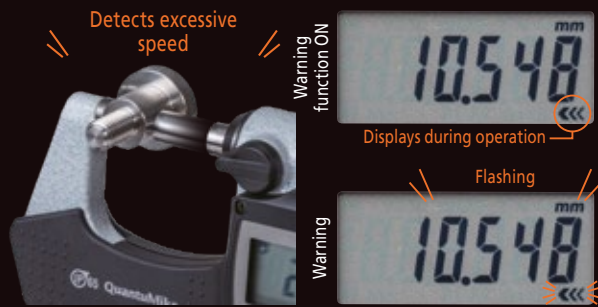

The approach speed warning function detects collisions with workpieces due to excessive speed. This way, even inexperienced workers can obtain stable and accurate measurement results.

Calibration Schedule Alert Function

NEW

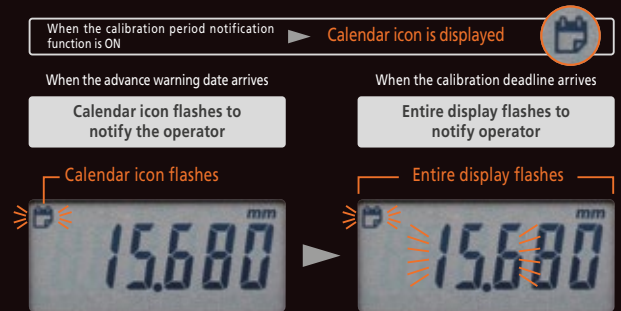

The calibration advance warning date and calibration date can easily be set. A warning is displayed when the calibration time approaches and on the calibration date to prevent skipped calibration. This is an effective function for proper management of the digimatic gauge.

Supports Measuring Workers With Tolerance Judgment and Calculation Functions

NEW

Measurement with QuantuMike

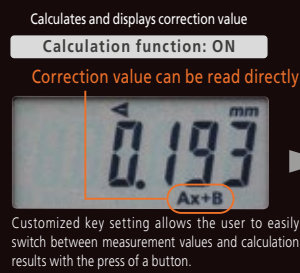

Simply enter the calculation result



The micrometer determines whether the measurement value is within the upper and lower limits of tolerance and displays a tolerance judgment mark. The user can judge pass/failure at a glance. Using the calculation function, it is also possible to calculate correction values for a processing machine from the measurement results. This eliminates the potential inconvenience of calculations and prevents human errors, such as confusing plus and minus values when entering correction values into a processing machine, thereby contributing to the reduction of processing defects.

Easy to use

- > Large display with excellent visibility
- > Large buttons and key customization
- > Dramatically improves work efficiency by connecting with a PC or mobile device

Digital Micrometer

+ For additional accessories and their compatibility, please find the table on page 42.



To see our whole range of micrometers, including technical details and accessories, scan the QR code.

293-821-30

~~€ 190,00~~ € 149,00
PROMO PRICE

Digital Standard Micrometer

Range 0-25 mm
Without data output

Digital Absolute Micrometer Quickmike IP65

Range 0-30 mm
With data output
With 10 mm feed/ thimble rotation

293-666-20

~~€ 587,00~~ € 469,00
PROMO PRICE

Also available:

293-667-20

~~€ 676,00~~ € 539,00
PROMO PRICE

Range 25-55 mm
With data output

Also available:

293-668-20

~~€ 725,00~~ € 579,00
PROMO PRICE

Range 50-80 mm
With data output

ABSOLUTE™

COOLANT PROOF™

IP65



Digital Micrometer IP65

Range 0-25 mm
With data output



IP65

COOLANT PROOF™

U-WAVE fit



0-25 mm and 25-50 mm

Also available:

293-234-30	
€ 379,00	€ 299,00 PROMO PRICE
Range 0-25 mm	
Ratched thimble type	
With data output	

Also available:

293-231-30	
€ 373,00	€ 299,00 PROMO PRICE
Range 25-50 mm	
With data output	

Also available:

293-232-30	
€ 490,00	€ 389,00 PROMO PRICE
Range 50-75 mm	
With data output	

Also available:

293-233-30	
€ 530,00	€ 419,00 PROMO PRICE
Range 75-100 mm	
With data output	

Wireless Set, U-WAVE Bluetooth

Transmitter + connector unit + IP65 micrometer



293-970	
€ 545,00	€ 399,00 PROMO PRICE

Range 0-25 mm
With data output

293-230-30
+ 264-626
+ 02AZF310

Digital Micrometer IP65 Set

Range 0-100 mm (4 pcs.)
With data output



293-963-30	
€ 1.810	€ 1.449 PROMO PRICE

Analog Micrometer



To see our whole range of micrometers, including technical details and accessories, scan the QR code.



0-25 mm and 25-50 mm

Outside Micrometer with Heat Ins. Plate

Range 0-25 mm



102-301

€ 67,00	€ 53,90 PROMO PRICE
--------------------	-------------------------------

Outside Micrometer Economy Design

Range 0-25 mm



103-137

€ 59,00	€ 46,90 PROMO PRICE
--------------------	-------------------------------

Outside Micrometer Economy Design

Range 25-50 mm



103-138

€ 84,00	€ 66,90 PROMO PRICE
--------------------	-------------------------------



Outside Micrometer Economy Design

Range 50-75 mm

103-139-10	
€ 110,00	€ 87,90 PROMO PRICE

Also available:

103-140-10	
€ 118,00	€ 94,90 PROMO PRICE
Range 75-100 mm	

Outside Micrometer Economy Design Set

Range 0-150 mm (6 pcs.)

103-913-50	
€ 598,00	€ 479,00 PROMO PRICE



Digit Outside Micrometer

Range 25-50 mm

193-102	
€ 232,00	€ 189,00 PROMO PRICE

Digital Micrometer

+ For additional accessories and their compatibility, please find the table on page 42.



U-WAVE^{fit}
except 422-411-20

COOLANT PROOF™



except 422-230-30 and 422-231-30



To see our whole range of micrometers, including technical details and accessories, scan the QR code.

Digital Disc Micrometer IP65

Range 0-25 mm
Disk 20 mm
With data output



323-250-30	
€ 851,00	€ 679,00 PROMO PRICE

Digital Disc Micrometer IP65

Range 25-50 mm
Disk 20 mm
With data output



323-251-30	
€ 948,00	€ 759,00 PROMO PRICE

Digital Spline Micrometer IP65

Range 0-25 mm
Measuring face 3 mm
With data output



331-251-30	
€ 814,00	€ 649,00 PROMO PRICE

Absolute Digital Blade Micrometer Quickmike IP65

Range 0-30 mm
Blade 0,75 mm
With data output



422-411-20	
€ 1.017	€ 809,00 PROMO PRICE

ABSOLUTE™

Digital Blade Micrometer

Range 0-25 mm
Blade 0,75 mm
With data output

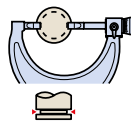

422-230-30	
€ 1.151	€ 919,00 PROMO PRICE

Also available:

422-231-30	
€ 1.208	€ 969,00 PROMO PRICE
Range 25-50 mm	
Blade 0,75 mm	
With data output	

156-101-10	
€ 79,00	€ 55,90 PROMO PRICE



Micrometer Stand, Adjustable Angle Type

For micrometer 0-100 mm/ 0-4"

Digital Crimp Height Micrometer IP65

Range 0-20 mm
With data output



342-271-30	
€ 720,00	€ 579,00 PROMO PRICE

Indicating Micrometer

Range 0-25 mm



510-121	
€ 859,00	€ 689,00 PROMO PRICE

Dial Snap Meter

Range 0-25 mm



523-121	
€ 744,00	€ 569,00 PROMO PRICE

Digital Calipers

+ For additional accessories and their compatibility, please find the table on page 42.



To see our whole range of calipers, including technical details and accessories, scan the QR code.

ABSOLUTE™

U-WAVE^{fit}



500-181-30

~~€ 134,00~~ € 99,90
PROMO PRICE

Digital ABS AOS Caliper

Range 0-150 mm
Flat rod
Without data output

Also available:

500-196-30	
€ 148,00	€ 129,00 PROMO PRICE
Range: 0-6"/ 0-150 mm	
Flat rod & with thumb roller	
Without data output	
Inch/metric switchable	

Also available:

500-184-30	
€ 134,00	€ 99,90 PROMO PRICE
Range 0 -150 mm	
Round rod	
Without data output	

Also available:

500-161-30	
€ 174,00	€ 139,00 PROMO PRICE
Range 0 -150 mm	
Flat rod	
With data output	

Also available:

500-158-30	
€ 200,00	€ 159,00 PROMO PRICE
Range 0 -150 mm	
Round rod & with thumb roller	
With data output	

Also available:

500-182-30	
€ 215,00	€ 169,00 PROMO PRICE
Range 0 -200 mm	
Flat rod	
Without data output	

Also available:

500-162-30	
€ 244,00	€ 189,00 PROMO PRICE
Range 0 -200 mm	
Flat rod	
With data output	

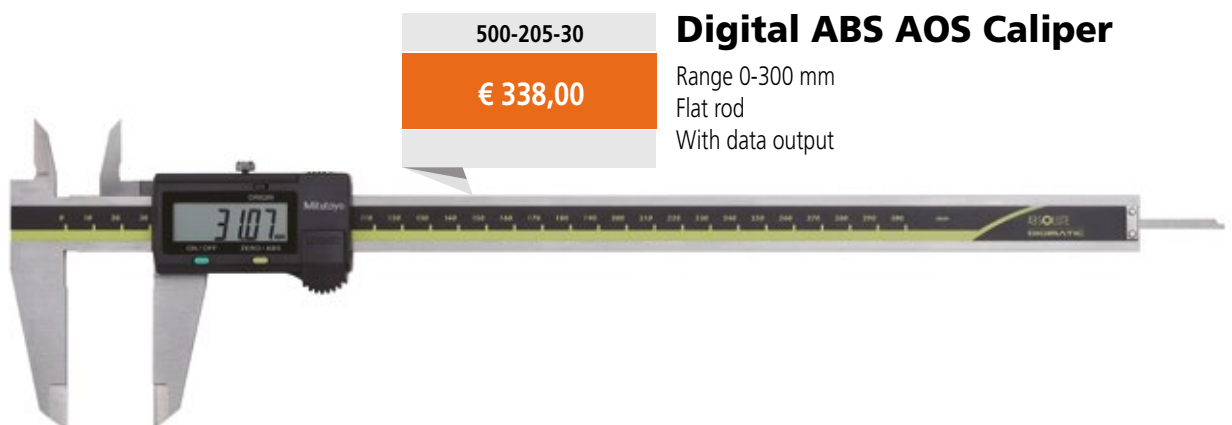

500-205-30

€ 338,00

Digital ABS AOS Caliper

Range 0-300 mm
Flat rod
With data output

Digital ABS Caliper IP67

Range 0-150 mm
Flat rod
Without data output



ABSOLUTE™ U-WAVE^{fit} COOLANT PROOF™



Also available:

500-716-20	
€ 256,00	€ 209,00 PROMO PRICE
Range 0 -150 mm	
Flat rod	
With data output	

Also available:

500-707-20	
€ 279,00	€ 219,00 PROMO PRICE
Range 0 - 200 mm	
Flat rod	
Without data output	

Also available:

500-717-20	
€ 325,00	€ 259,00 PROMO PRICE
Range 0 - 200 mm	
Flat rod	
With data output	

Also available:

500-708-20	
€ 401,00	€ 319,00 PROMO PRICE
Range 0 - 300 mm	
Flat rod	
Without data output	

Wireless Set U-WAVE Bluetooth

Transmitter + connection unit + caliper

Wireless Set U-WAVE Bluetooth

Transmitter + connection unit + IP67 caliper



(except 500-961-30)



Digital ABS Caliper IP67

Nib style jaws
Range 0-300 mm

550-331-20

€ 550,00	€ 439,00 PROMO PRICE
---------------------	-------------------------



ABSOLUTE™ U-WAVEfit COOLANT PROOF™ IP67

Digital ABS Caliper

Nib style jaws
Range 0-1000 mm

550-207-10

€ 1.462	€ 1.169 PROMO PRICE
--------------------	------------------------

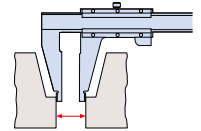

ABSOLUTE™

Digital ABS Caliper IP67

Nib style and standard jaws
Range 0-300 mm

551-331-20

€ 596,00	€ 479,00 PROMO PRICE
---------------------	-------------------------

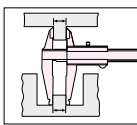

ABSOLUTE™ U-WAVEfit COOLANT PROOF™ IP67

Digital ABS Carbon Fibre Caliper IP66

Range 0-2000 mm

552-306-10

€ 3.000	€ 2.469 PROMO PRICE
--------------------	------------------------



ABSOLUTE™ COOLANT PROOF™ IP66



Lightweight: 2,56 kg

Analog Calipers



To see our whole range of calipers, including technical details and accessories, scan the QR code.

Vernier Caliper

Range 0-150 mm
0,05 mm
Metric

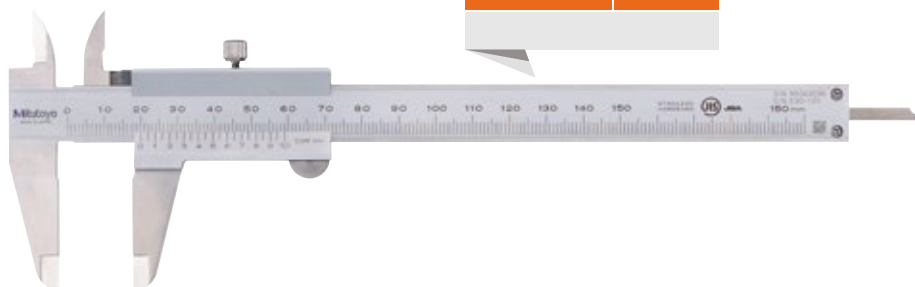

530-101	
€ 38,00	€ 28,90 PROMO PRICE

Also available:

530-104	
€ 39,00	€ 29,90 PROMO PRICE
Range 0 - 150 mm /0-6"	
0,05 mm/1/128"	
Metric/inch	

Also available:

530-122	
€ 46,00	€ 36,90 PROMO PRICE
Range 0 - 150 mm	
0,02 mm	
Metric	

Also available:

530-123	
€ 75,00	€ 59,90 PROMO PRICE
Range 0 - 200 mm	
0,02 mm	
Metric	

Also available:

530-124	
€ 229,00	€ 179,00 PROMO PRICE
Range 0 - 300 mm	
0,02 mm	
Metric	

Dial Caliper

Range 0-150 mm,
0,02 mm, 2 mm/rev
Metric



505-730	
€ 122,00	€ 90,90 PROMO PRICE

Also available:

505-732	
€ 140,00	€ 99,90 PROMO PRICE
Range 0 - 150 mm	
0,01 mm, 1 mm/rev.	
Metric	

Indicators & Dial Test Indicators



To see our whole range of indicators & dial test indicators, including technical details and accessories, scan the QR code.

+ For additional accessories and their compatibility, please find the table on page 42.



Dial Gauge

Lug back
Range: 10 mm
Graduation: 0,01 mm



2046A	
€ 49,00	€ 38,90 PROMO PRICE

Also available:

2046AB	
€ 48,00	€ 37,90 PROMO PRICE
Flat back	
10 mm, 0,01 mm	

Also available:

2046AB-60	
€ 141,00	€ 98,90 PROMO PRICE
Flat back	
IP64, 10 mm, 0,01 mm	

Dial Test Indicator

Horizontal type
Range: 0,14 mm
Graduation: 0,001 mm
With 8 mm stem



513-401-10E	
€ 187,00	€ 149,00 PROMO PRICE

Also available:

513-404-10E	
€ 105,00	€ 84,90 PROMO PRICE
Horizontal type	
0,8 mm, 0,01 mm	
with 8 mm stem	

Dial Test Indicator

Vertical type
Range: 0,8 mm, graduation: 0,01 mm
With 8 mm stem

513-454-10E

€ 130,00	€ 99,90 PROMO PRICE
---------------------	-------------------------------



Dial Test Indicator

Horizontal type
Range: 0,8 mm, graduation: 0,01 mm
With magnetic stand

513-908-10E

€ 167,00	€ 129,00 PROMO PRICE
---------------------	--------------------------------



Digital ABS Indicator ID-C

With bidirectional interface digimatic S1
Flat back plate, range: 12,7 mm, digital step: 0,0005 mm

543-700B

€ 446,00	€ 359,00 PROMO PRICE
---------------------	--------------------------------



Also available:

543-710B

€ 333,00	€ 269,00 PROMO PRICE
---------------------	--------------------------------

Flat back plate
12,7 mm, 0,01 mm

Also available:

543-720B

€ 567,00	€ 449,00 PROMO PRICE
---------------------	--------------------------------

Flat back plate
25,4 mm, 0,0005 mm

Also available:

543-730B

€ 848,00	€ 679,00 PROMO PRICE
---------------------	--------------------------------

Flat back plate
50,8 mm, 0,0005 mm

DIGIMATIC S1
ABSOLUTE™

Digital ABS Indicator ID-S

Flat back plate, range: 12,7 mm, digital step: 0,01 mm

543-781B-10

€ 187,00	€ 149,00 PROMO PRICE
---------------------	--------------------------------



Also available:

543-791B-10

€ 357,00	€ 289,00 PROMO PRICE
---------------------	--------------------------------

Flat back plate
0,5"/12,7 mm, 0,00005"/0,001 mm
Inch/metric

ABSOLUTE™

DIGIMATIC S1

ABSOLUTE™



543-855B-D

~~€ 818,00~~

€ 649,00
PROMO PRICE

Digital ABS Indicator ID-F

With bidirectional interface digimatic S1
With CEE AC-adapter/ flat back plate
Range: 12,7 mm, digital step: 0,0005 mm

Also available:

543-851D

~~€ 937,00~~

€ 749,00
PROMO PRICE

25,4 mm, 0,0005 mm

Also available:

543-853D

~~€ 1.015~~

€ 809,00
PROMO PRICE

50,8 mm, 0,0005 mm



OK



NG



Digital ABS Indicator ID-C

Peak hold (MAX/MIN/RANGE) function
Flat back plate
Range: 12,7 mm, digital step: 0,001 mm

ABSOLUTE™



543-300B-10

~~€ 511,00~~

€ 409,00
PROMO PRICE



High Accuracy Digital Indicator ID-H

Accuracy: E_{MPE} 1,5 μ m
 With CEE AC-adaptor/ flat back plate
 Range: 30,4 mm, digital step: 0,0005 mm

543-561D	
€ 940,00	€ 749,00 PROMO PRICE

Also available:

543-563D	
€ 1.164	€ 929,00 PROMO PRICE
Accuracy: E_{MPE} 2,5 μ m	
60,9 mm, 0,0005 mm	



Remote Controller

For ID-H indicator

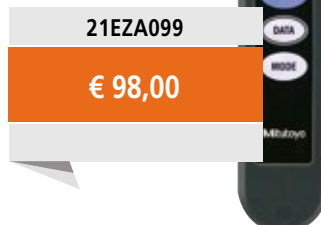

21EZA099	
€ 98,00	

Spindle Lifting Lever

For dial indicators and digital indicators, please refer to the accessory list on page 42

Also available:	
21EZA198	21AZB149
€ 15,00	€ 11,00



Spindle Lifting Cable

For dial indicators and digital indicators, please refer to the accessory list on page 42

L = 500 mm

21JZA295	
€ 29,20	



Contact Element Set

M2,5x0,45
6 pcs., metric

7822	
€ 229,00	€ 179,00 PROMO PRICE



Jointed Magnetic Stand

Approx. 250 mm working radius

7032-10	
€ 461,00	€ 369,00 PROMO PRICE

Also available:

7031-10	
€ 438,00	€ 349,00 PROMO PRICE
approx. 154 mm working radius	

Also available:

7033-10	
€ 499,00	€ 399,00 PROMO PRICE
approx. 346 mm working radius	

2-Point Inside Measuring Instrument

18-150 mm
With digital indicator, 0,001 mm

511-925-20	
€ 1.143	€ 919,00 PROMO PRICE



Inside Micrometers

+ For additional accessories and their compatibility, please find the table on page 42.



To see our whole range of inside micrometers, including technical details and accessories, scan the QR code.



3-Point Internal Micrometer Holtest Set

6-12 mm (3 pcs.)
With titanium coated contact points

368-911		
€ 1.091	€ 899,00 PROMO PRICE	

Also available:

368-912	
€ 942,00	€ 769,00 PROMO PRICE
12-20 mm, (2 pcs.)	

Also available:

368-913	
€ 2.160	€ 1.779 PROMO PRICE
20-50 mm, (4 pcs.)	

Also available:

368-914	
€ 2.501	€ 2.059 PROMO PRICE
50-100 mm, (4 pcs.)	

3-Point Internal Micrometer Holtest Set

50-100 mm (4 pcs.), economy set
With contact points of alloy steel

368-993		
€ 2.406	€ 1.979 PROMO PRICE	

Digital 3-Point Internal Micrometer Set

6-12 mm (3 pcs.)
Complete unit
IP65



COOLANT PROOF™

Also available:

468-981	
€ 3.310	€ 2.649 PROMO PRICE

Also available:

468-982	
€ 3.670	€ 2.939 PROMO PRICE
12-25 mm, (3 pcs.)	
Complete unit, IP65	

Also available:

468-983	
€ 3.973	€ 3.179 PROMO PRICE
25-50 mm, (3 pcs.)	
Complete unit, IP65	

Also available:

468-984	
€ 3.064	€ 2.449 PROMO PRICE
50-75 mm, (2 pcs.)	
Complete unit, IP65	

Also available:

468-985	
€ 3.653	€ 2.899 PROMO PRICE
75-100 mm, (2 pcs.)	
Complete unit, IP65	

Depth Measuring

+ For additional accessories and their compatibility, please find the table on page 42.



To see our whole range of depth measuring instruments, including technical details and accessories, scan the QR code.

U-WAVE fit



ABSOLUTE™

COOLANT PROOF™

IP67

Digital ABS Depth Gauge IP67

0-200 mm
100 mm base

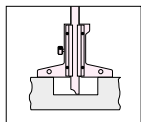

571-252-20
~~€ 534,00~~ € 409,00
PROMO PRICE

Dial Indicator Depth Gauge

0-200 mm
63,5 mm base
With 5 extension rods

7211A
~~€ 241,00~~ € 189,00
PROMO PRICE



Depth Micrometer

0-25 mm
63,5 mm base

128-101
~~€ 174,00~~ € 139,00
PROMO PRICE



Gauge Blocks



To see our whole range of gauge blocks, including technical details and accessories, scan the QR code.



Gauge Block Set

Metric, inspection certificate, ISO
47 blocks, grade 0, steel



516-962-10

~~€ 2.027~~

€ 1.619
PROMO PRICE

Also available:

516-963-10

~~€ 1.561~~

€ 1.249
PROMO PRICE

Metric, inspection certificate, ISO

47 blocks, grade 1, steel

Also available:

516-964-10

~~€ 1.327~~

€ 1.059
PROMO PRICE

Metric, inspection certificate, ISO

47 blocks, grade 2, steel

Height Gauges

+ For additional accessories and their compatibility, please find the table on page 42.



To see our whole range of height gauges, including technical details and accessories, scan the QR code.

Digital ABS Height Gauge

0-300 mm, 0,01 mm
With handwheel

570-402	
€ 786,00	€ 619,00 PROMO PRICE

ABSOLUTE™



Also available:

570-404	
€ 1.382	€ 1.079 PROMO PRICE
0-600 mm, 0,01 mm	
With handwheel	

Also available:

570-414	
€ 1.382	€ 1.079 PROMO PRICE
0-24"/0-600 mm, 0,0005"/0,01 mm	
With handwheel	
Inch/metric	

Digital Height Gauge Double Column

0-1000 mm, 0,005 mm

192-615-10	
€ 2.746	€ 2.199 PROMO PRICE



Data Management

+ For additional accessories and their compatibility, please find the table on page 42.



To see our whole range of data management products, including technical details and accessories, scan the QR code.

USB-ITPAK Vers. 3.0

Full version
USB dongle + manual (software available online)

USB-ITPAK Version 3 is software for collecting data from measuring instruments with digimatic, data output to Excel by using USB Input Tool Interface Box, USB Input Tool Direct Cables, U-WAVE wireless system and DP-1VA printer/logger.

06AGR543
~~€ 340,00~~ € 259,00
PROMO PRICE

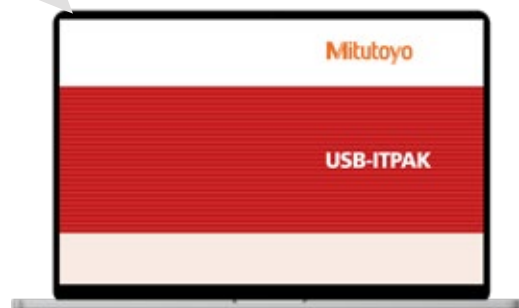

USB Input Tool Interface Box

The USB input tool interface box is used for connecting measuring instruments with a digimatic data output to a USB-port of a PC. Keyboard format (HID) or virtual com-port (VCP).

264-020
~~€ 259,00~~ € 209,00
PROMO PRICE



Statistic Processing Printer/Logger DP-1VA

This data printer and logger is used for printing measurement data from measuring instruments with digimatic data output and to perform statistical analysis.

264-505D
~~€ 546,00~~ € 439,00
PROMO PRICE



Digimatic Cables

Digimatic to USB Cables



Digimatic cables are used for connecting measuring instruments with digimatic data output e.g. to USB input tool interface box or DP-1VA printer.

Digimatic Cable, Flat Straight Type

1 m cable



905338	Also available: 905409
€ 37,00	€ 44,00
	2 m cable

Digimatic Cable, Flat 10-Pin Type

1 m cable



936937	Also available: 965014
€ 57,00	€ 72,00
	2 m cable

Digimatic Cable, Straight, Data Button

1 m cable



959149	Also available: 959150
€ 48,00	€ 57,00
	2 m cable

Digimatic Cable with Data Button IP Type

1 m cable
Caliper type



05CZA624	Also available: 05CZA625
€ 100,00	€ 107,00
	2 m cable

Also available: 05CZA662	Also available: 05CZA663
€ 105,00	€ 107,00
1 m cable Micrometer type	2 m cable Micrometer type

Digimatic Cable, Straight

1 m cable, Digimatic/ Digimatic 2/
Digimatic S1 interface



06AGL011	Also available: 06AGL021
€ 79,00	€ 84,00
	2 m cable

Digimatic Cable with Data Button IP Type

1 m cable, Digimatic/ Digimatic 2/
Digimatic S1 interface



06AGL111	Also available: 06AGL121
€ 129,00	€ 138,00
	2 m cable



Digimatic to USB cables for connecting measuring instruments with digimatic data output e.g. to the USB-port of a PC. Keyboard format (HID) or virtual COM-port (VCP).

+ For additional accessories and their compatibility, please find the table on page 42.

USB Input Tool Direct (Digimatic to USB)

2 m cable, with data button
IP caliper 67 type

06AFM380A	
€ 141,00	€ 109,00 PROMO PRICE

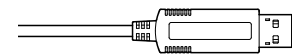

USB A connector to PC



Also available:

06AFM380B	
€ 141,00	€ 109,00 PROMO PRICE
2 m cable	
IP micrometer type	
With data button	

Also available:

06AFM380C	
€ 124,00	€ 98,90 PROMO PRICE
2 m cable	
Straight	
With data button	

Also available:

06AFM380D	
€ 124,00	€ 98,90 PROMO PRICE
2 m cable	
Flat 10-pin type	

Also available:

06AFM380E	
€ 124,00	€ 98,90 PROMO PRICE
2 m cable	
Round 6-pin type	

Also available:

06AFM380F	
€ 124,00	€ 98,90 PROMO PRICE
2 m cable	
Flat straight type	

Also available:

06AFM380G	
€ 124,00	€ 98,90 PROMO PRICE
2 m cable	
Flat straight for ID-N/ID-B	

Also available:

06AGQ001A	
€ 145,00	€ 119,00 PROMO PRICE
2 m cable	
Digimatic S1 interface	
IP type	

Also available:

06AGQ001F	
€ 164,00	€ 129,00 PROMO PRICE
2 m cable	
Digimatic S1 interface	
Straight	

USB Input Tool Direct Footswitch Adapter

For Mitutoyo Software USB-ITPAK or Mitutoyo MeasurLink



06ADV384	
€ 129,00	€ 99,90 PROMO PRICE

Footswitch for SPC



937179T	
€ 56,00	

To see our wireless communication system U-WAVE, including technical details, scan the QR code.



U-WAVE-R Wireless Receiver

For U-WAVE fit and U-WAVE-T transmitter based on IEEE802.15.4 (2,4 GHz)



02AZD810D

€ 371,00	€ 249,00 PROMO PRICE
---------------------	-------------------------

U-WAVE fit

Wireless transmitter for micrometer/indicator based on IEEE802.15.4 (2,4 GHz) IP67 type



264-622

€ 185,00	€ 139,00 PROMO PRICE
---------------------	-------------------------

Also available:

264-623

€ 185,00	€ 139,00 PROMO PRICE
For micrometer/ indicator	
Buzzer type	

U-WAVE fit

Wireless transmitter for caliper based on IEEE802.15.4 (2,4 GHz) IP67 type



264-620

€ 185,00	€ 139,00 PROMO PRICE
---------------------	-------------------------

Also available:

264-621

€ 185,00	€ 139,00 PROMO PRICE
For caliper	
Buzzer type	

U-WAVE-T

Wireless transmitter for miscellaneous measuring instruments based on IEEE802.15.4 (2,4 GHz) Buzzer type



02AZD880G

€ 187,00	€ 129,00 PROMO PRICE
---------------------	-------------------------

Also available:

02AZD730G

€ 187,00	€ 129,00 PROMO PRICE
IP67 type	

U-WAVE fit Bluetooth

Wireless transmitter for micrometer/ indicator IP67 type



264-626

€ 185,00	€ 139,00 PROMO PRICE
---------------------	-------------------------

Also available:

264-627

€ 185,00	€ 139,00 PROMO PRICE
For micrometer/indicator	
Buzzer type	

U-WAVE fit Bluetooth

Wireless transmitter for caliper IP67 type



264-624

€ 185,00	€ 139,00 PROMO PRICE
---------------------	-------------------------

Also available:

264-625

€ 185,00	€ 139,00 PROMO PRICE
For caliper	
Buzzer type	

Connection Unit for caliper

For U-WAVE fit,
U-WAVE fit Bluetooth

02AZF300

~~€ 105,00~~ € 74,90
PROMO PRICE



Connection Unit for ID-C Indicator

U-WAVE fit, U-WAVE fit Bluetooth
for Digimatic S1 interface, for new
12,7 mm ID-C Indicator only

02AZF700

~~€ 124,00~~ € 99,90
PROMO PRICE



Connection Unit IP Caliper/Micrometer

With data button for U-WAVE fit,
U-WAVE fit Bluetooth

02AZF310

~~€ 110,00~~ € 74,90
PROMO PRICE



Connection Unit for IP Micrometer new QuantuMike

U-WAVE fit, U-WAVE fit Bluetooth
for digimatic S1 interface

02AZF960

~~€ 107,00~~ € 74,90
PROMO PRICE



Connection Cable for all U-WAVE Transmitter

Connection cable for U-WAVE
with data button for IP caliper type

02AZD790A

~~€ 110,00~~ € 59,90
PROMO PRICE



Also available:

02AZD790B

~~€ 110,00~~ € 59,90
PROMO PRICE

For IP micrometer type

With data button

Also available:

02AZD790C

~~€ 105,00~~ € 54,90
PROMO PRICE

Straight

With data button

Also available:

02AZD790D

~~€ 98,00~~ € 52,90
PROMO PRICE

Flat 10-Pin type

Also available:

02AZD790E

~~€ 98,00~~ € 52,90
PROMO PRICE

Round 6-pin type

Also available:

02AZD790F

~~€ 98,00~~ € 52,90
PROMO PRICE

Straight

Without data button

Also available:

02AZD790G

~~€ 105,00~~ € 52,90
PROMO PRICE

For IP66 Indicators ID-N & ID-B

Also available:

02AZG011

~~€ 134,00~~ € 109,00
PROMO PRICE

Digimatic S1 interface

Straight

Linear Height

LH-600 F/FG



To see our Linear Height, including its technical details and accessories, scan the QR code.

DIGIMATIC S1



- > Measurement operations can be performed by using the hybrid controller box with a touch screen and integrated sheet keyboard
- > Capable of measuring with a digital step of 0,1 μm
- > Excellent accuracy of $(1,1 + 0,6L/600) \mu\text{m}$
- > Bidirectional Digimatic data output (Digimatic S1)
- > Measurement results can be printed from a receipt printer or Digimatic Printer (DP-1VA) and sent to a PC via wireless communication based on IEEE802.15.4 or Bluetooth
- > Pneumatic drive mechanism
- > Automatic running of pre-learned part programs
- > Excellent visualization of GO/ \pm NG tolerance comparisons
- > Independent operation with rechargeable battery
- > LH-communication tool software available online free of charge

All sets include E-learning and Stylus Kit:

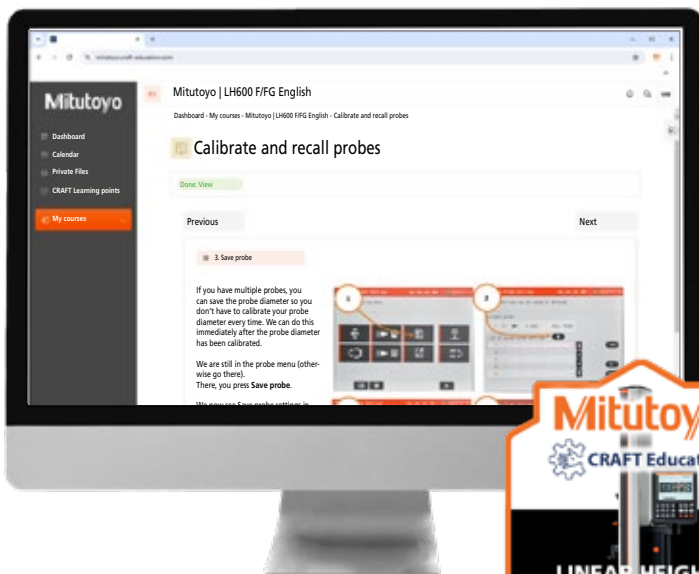

LH-600FG SET

Model with power grip,
including an e-learning course,
stylus kit, and CEE AC power cord

Range 0-977 mm
Digital step 0,0001 mm
Set consists of
1 pc. linear height LH-600 FG
Height gauge
Stylus kit M3 for Linear Height
Power cable CEE type

PROMO016	
€ 9.629,70	€ 7.579 PROMO PRICE

LH-600F SET

Model without power grip,
including an e-learning course,
stylus kit, and CEE AC power cord

Range 0-977 mm
Digital step 0,0001 mm
Set consists of
1 pc. linear height LH-600 F
Height gauge
Stylus Kit M3 for Linear Height
Power cable CEE type

PROMO015	
€ 9.182,70	€ 7.179 PROMO PRICE

With excellent
accuracy of
 $(1,1 + 0,6L/600) \mu\text{m}$

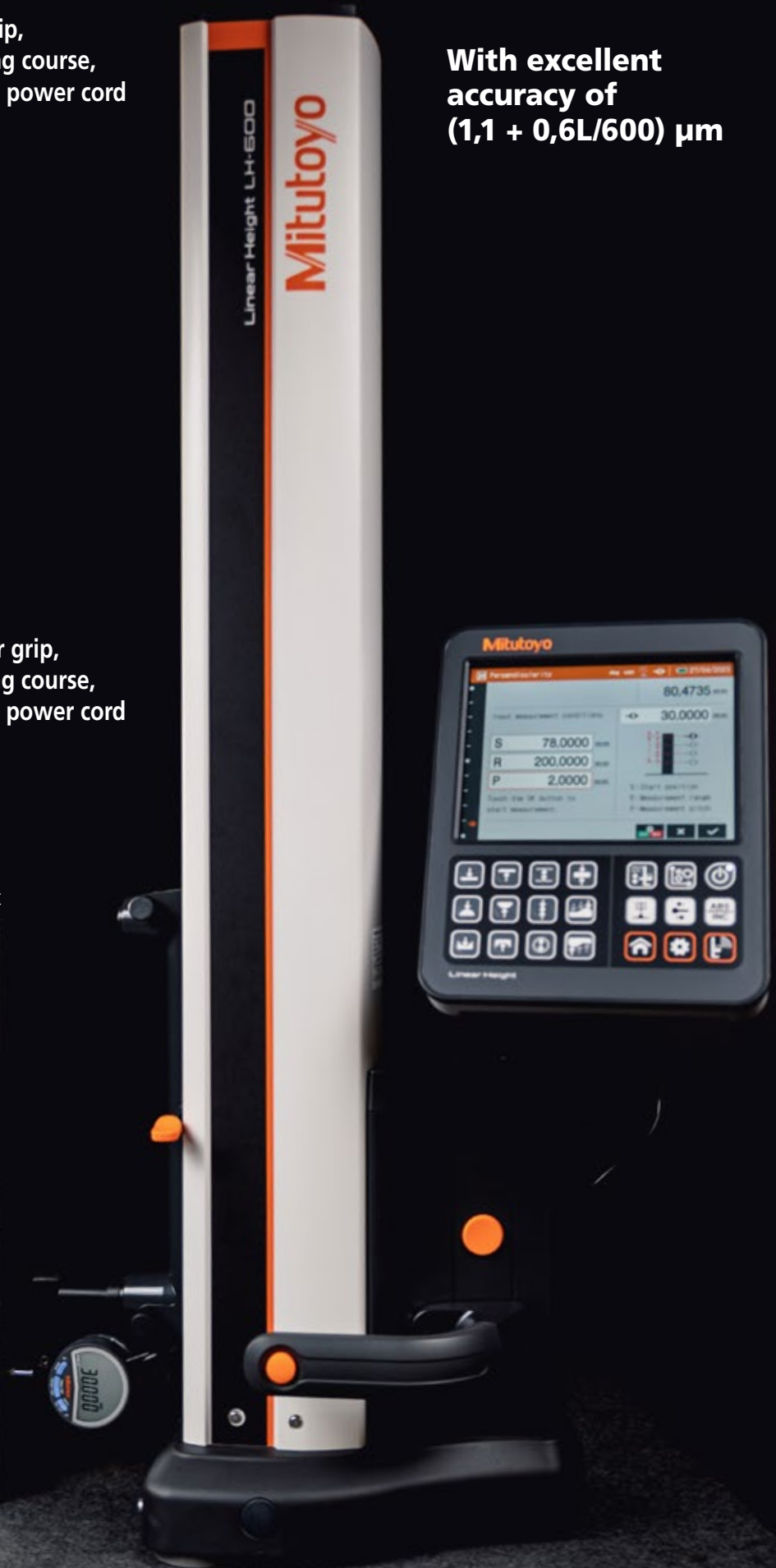

Surftest and Accessories



To see our whole range of surface roughness measuring instruments, including technical details and accessories, scan the QR code.

Surftest SJ-310

R2 μm ; 0,75 mN



178-570-11D

~~€ 4.950~~

€ 3.959
PROMO PRICE

Surftest SJ-410 series

SJ-411: X = 25 mm
SJ-412: X = 50 mm



Surftest SJ-411

R2 μm ; 0.75 mN; X=25 mm

Surftest SJ-412

R2 μm ; 0.75 mN; X=50 mm

178-580-11D

~~€ 9.350~~

€ 7.659
PROMO PRICE

178-582-31D

~~€ 10.980~~

€ 8.999
PROMO PRICE

- > Portable instruments that allow easy and accurate on-site measuring of surface roughness, independent of external power sources.
- > Boasting comfortable use, the SJ Series retains an easy and intuitive menu navigation.
- > The large 14,5 cm color LCD touchscreen facilitates easy readout and operation in multiple languages.
- > With the built-in printer, results, profiles, conditions, and more can be printed out automatically or on demand.
- > The SJ-410 Series' skidless design enables the creation of primary profiles (P), roughness profiles (R), waviness profiles (W), and more. It also offers surface compensation of curved, radial, and tilted surfaces.
- > The SJ-410 Series features a high straightness drive unit with a traverse length of 25 mm and 50 mm. There is a large number of easy to replace styli compatible with both lengths for customers to choose from.

X-Axis Adjustment Unit



Digital Leveling Unit



Autoset Unit



Granite Stand



- > The SJ-410 Series offers several optional accessories like the autoset unit, X-axis adjustment unit, and digital leveling unit that can be mounted on the granite stand – individually or combined.

Hardness Sets



These are six economical Rockwell hardness testing machines to suit practically every application you may need.

HR-200/300/400 Series

- > They are very simple to operate: the analog type HR-210 uses an automatic presetting dial gauge.
- > Digital models HR-320/430 use automatic steering wheel braking to prevent over application of test force.
- > Digital models HR-320MS and HR-430MR/MS can use our digimatic mini-processor (DP-1VA) for printing.

HR-530 Series

- > Load cell based electronic test force application and control.
- > Serial test mode with foot switch control (foot switch optional).
- > Inside testing capability from \varnothing 36mm (standard indenter) or \varnothing 22mm (optional indenter 63DIA007).
- > Use our digimatic Mini-processor (DP-1VA) for printing results, and you can use an input tool (USB-ITN-D) to connect to a PC for data transfer, analysis, and storage.
- > Additional test methods: Brinell test, HBT, Rockwell plastic test, Accessories required: Indenters and a measurement microscope.

K543817

~~€ 525,00~~ € 429,00
PROMO PRICE



Compatible with **HR-210MR** and **HR-430MR**



HR-210MR-SET01

~~€ 5.383~~ € 4.599
PROMO PRICE



HR-320MS-SET01

~~€ 7.913~~ € 6.699
PROMO PRICE

HR-210MR Set Rockwell Hardness Testing Machine

HR-320 MS SetDual Type (Rockwell/Rockwell Superficial) Hardness Testing Machine

All Sets Include:

Accessories with DAkkS calibration certificates confirming to DIN EN ISO 6508 and ASTM E18
Made in Germany

+ For additional accessories and their compatibility, please find the table on page 42.

Diamond Cone Indenter for Rockwell Test, Standard Type

With DAkkS calibration certificate conforming to ISO 6508-2 and ASTM E18 Class B without function test
Item number: 63DIA023

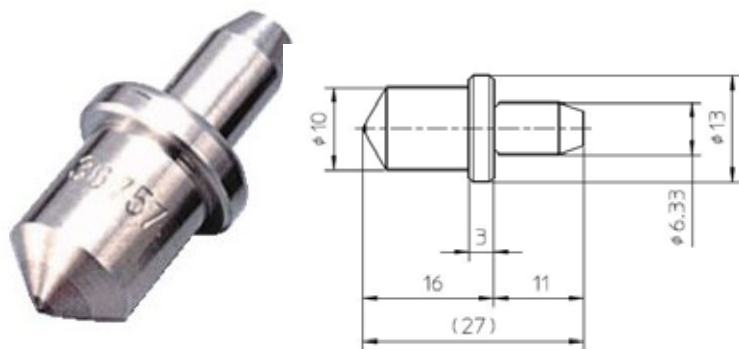

60HRC Rockwell Hardness Reference Material

With DAkkS calibration certificate conforming to ISO 6508-3 and ASTM E18, 60x60x16mm, steel, standard conform grid lasered on top
Item number: 63ETB040DG

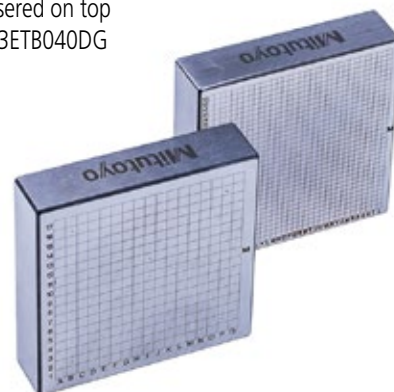

HR-530L-SET01

~~€14.150,70~~ € 11.399
PROMO PRICE

HR-530-SET01

~~€11.715,70~~ € 9.299
PROMO PRICE

HR-430MR-SET01

~~€ 8.673~~ € 7.399
PROMO PRICE

HR-430MS-SET01

~~€ 9.733~~ € 8.299
PROMO PRICE

HR-530L Set

HR-530 Set

HR-430MR Set

HR-430MS Set

Linear Scales

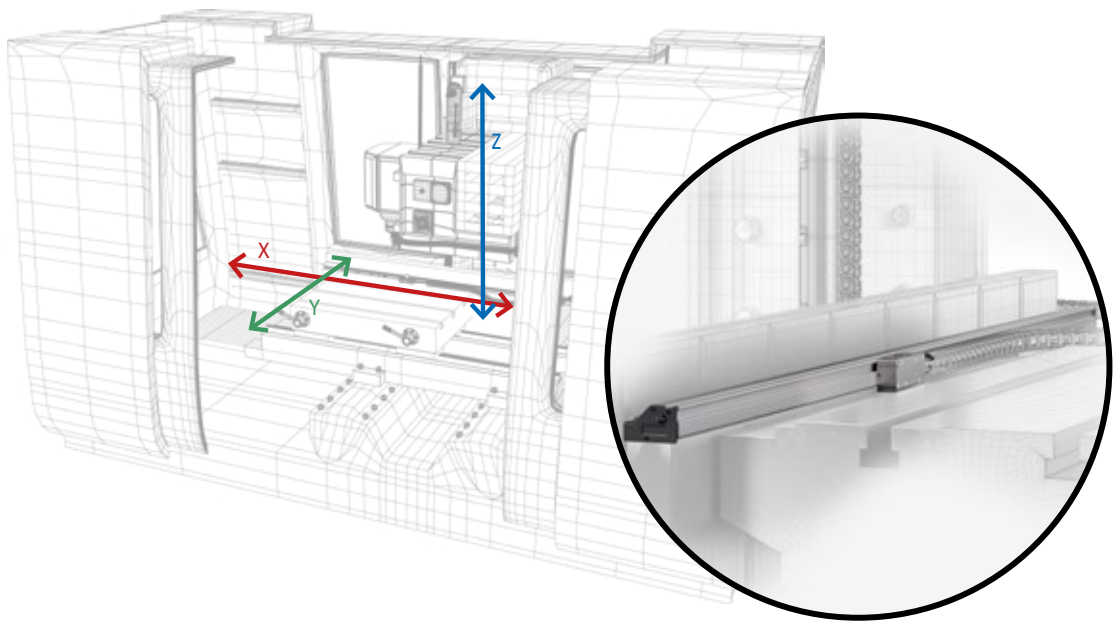

Linear Scale Counter KA-212

174-183D

~~€ 650,00~~

€ 539,00
PROMO PRICE



Linear Scale Counter KA-213

174-185D

~~€ 782,00~~

€ 639,00
PROMO PRICE



539-8XX-2

€ 1.190

2-axis KA-200 COUNTER plus two scales with max. 2.000 mm effective range

2-axis KA-200 COUNTER + two scales, max. effective range 2000 mm

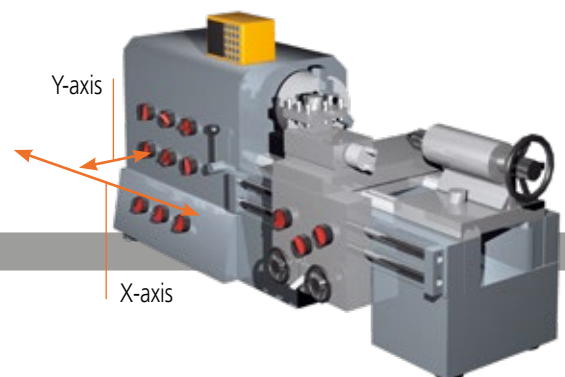

Kit for New and Used Manual Machine Tools

- Linear Scale AT-715 and KA-200 COUNTER. This offer consists of scales with 2 or 3 readouts.
- Linear scales with an effective range of max. 3000 mm per scale.
- ABSOLUTE technology – no reference point setup required at power-on.
- IP67 protection - thanks to electromagnetic induction scanning principle (high durability and resistance to dust, water, and oil).
- High accuracy (from $\pm 5 \mu\text{m}$ up to $\pm 10 \mu\text{m}$), depending upon the effective range.
- Easy application in several types of manual machine tools, especially lathes.



ABSOLUTE™

IP67

Additional measuring ranges are available
(not included in basic sets 1 and 2)

No.	Effective range (mm)	Total length (mm)	List price €
539-860N	2.000	2.198	1.050,00
539-861N	2.200	2.398	1.130,00
539-862N	2.400	2.598	1.341,00
539-863N	2.500	2.698	1.381,00
539-864N	2.600	2.798	1.423,00
539-865N	2.800	2.998	1.515,00
539-866N	3.000	3.198	1.683,00

Max. traveling speed	Effective range	Accuracy
50 m/min	100–500 mm	$\pm 5 \mu\text{m}$
	600–1.800 mm	$\pm 7 \mu\text{m}$
	2.000–3.000 mm	$\pm 10 \mu\text{m}$

The offered set contains linear scales
with a range of up to 1800 mm

No.	Effective range (mm)	Total length (mm)
539-801R	100	278
539-802R	150	328
539-803N	200	378
539-804N	250	428
539-805N	300	488
539-806N	350	538
539-807N	400	588
539-808N	450	638
539-809R	500	698
539-811N	600	798
539-813N	700	898
539-814N	750	938
539-815N	800	998
539-816N	900	1.098
539-817N	1.000	1.198
539-818R	1.100	1.298
539-819R	1.200	1.398
539-820N	1.300	1.498
539-821R	1.400	1.598
539-822N	1.500	1.698
539-823R	1.600	1.798
539-824N	1.700	1.898
539-825N	1.800	1.998

539-8XX-3

€ 1.490

3-axis KA-200 COUNTER plus three scales
with max. 3.000 mm effective range

3-axis KA-200 COUNTER + three scales, max. effective range 3000 mm



+



+



+

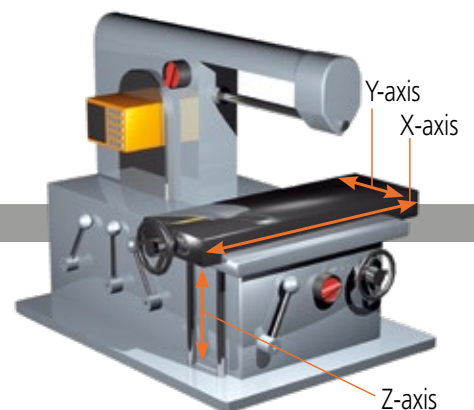

Fixture Sets



Mitutoyo fixture equipment is designed and manufactured with uncompromising precision in mind. Additionally, universality, flexibility, repeatability, and efficiency are essential aspects for choosing Mitutoyo fixturing systems. Quintessentially, our products are the result of over 40 years of experience in fixture system development.

MiSTAR Styli Kit M2 M3

Styli components optimized for the use with MiSTAR CMM, 15 pieces

K651445

~~€ 857,00~~

€ 699,00
PROMO PRICE



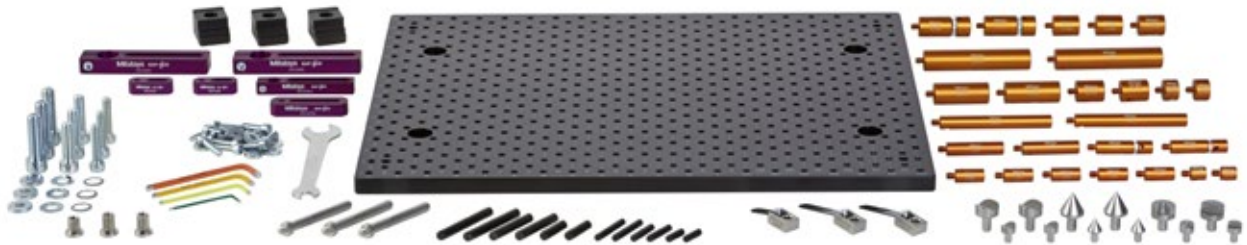
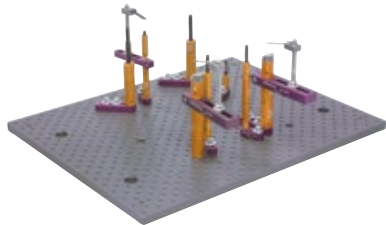
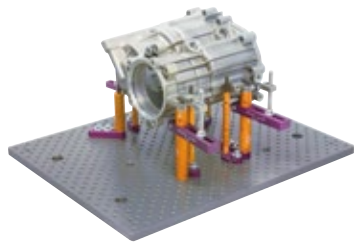

eco-fix Kit L, 98pcs.

CMM fixtures, eco-fix series

Also available:

K551549		K551048	
€ 1.979	€ 1.679 PROMO PRICE	€ 1.062	€ 899,00 PROMO PRICE
eco-fix kit S, 59 pcs.			



Above-mentioned prices are Mitutoyo's suggested non-binding retail prices without VAT.

MeasurLink 10



MeasurLink is Mitutoyo's data collection and Statistical Process Control (SPC) software solution. It is the ideal solution to automate and centralize data collection, analyze inspection data, monitor process performance, reduce scrap and ultimately enhance product quality and customer satisfaction. MeasurLink captures measurement data from sensors and gauges connected via Real-Time Professional V10, ensuring precise and consistent process analysis.

ML Real-Time Professional V10

Real-Time Professional Edition is the essential tool for data collection from measurement instruments, which ensures seamless integration. It is therefore designed for customers that need to connect to major instruments, such as CMMs, vision and form, etc. systems via DDE or ASCII file import.

64AAB837R

~~€ 2.060~~ € 1.549
PROMO PRICE

ML Real-Time Professional 3D V10

Real-Time Professional 3D Edition adds true 3D model support, enhancing data visualization and analysis capabilities with three-dimensional representations.

64AAB838R

~~€ 2.288~~ € 1.719
PROMO PRICE

ML Process Analyzer Professional V10

Process Analyzer Professional Edition analyzes data collected on all networked real-time stations to identify problem areas, take corrective action, and improve the quality of your product. Inspection data can be merged, filtered, charted, and printed to identify long term trends and identify root causes for process improvement.

64AAB839R

~~€ 2.060~~ € 1.539
PROMO PRICE

ML Process Manager V10

Process Manager is a dashboard view of the current shop floor activity. It provides managers with the perfect tool to organize and maintain a shop-wide quality program at a glance.

64AAB840R

~~€ 2.060~~ € 1.539
PROMO PRICE

ML Report Scheduler V10

MeasurLink 10 Report Scheduler automates report creation and distribution by email or export in various formats. It generates reports based on logged tasks, ensuring timely and accurate data delivery, without manual intervention.



64AAB853R

~~€ 2.060~~ € 1.539
PROMO PRICE

ML Gauge Management V10

Gauge Management Standard Edition organizes and manages gauge information, establishes calibration standards, and builds a metrology asset database. It generates calibration procedures with detailed instructions and provides reports on due or overdue calibrations.



64AAB842R

~~€ 2.060~~ € 1.539
PROMO PRICE

ML Site License V10

30 Licenses

64AAB843R **64AAB843FR**

~~€ 22.880~~ € 18.299
PROMO PRICE

~~€ 11.492~~ € 9.199
PROMO PRICE

Floating license

Also available:

ML Gauge R&R V10

MeasurLink Gauge R&R determines a measurement system's capability using a set of techniques designed to ensure accuracy for any measurement task.

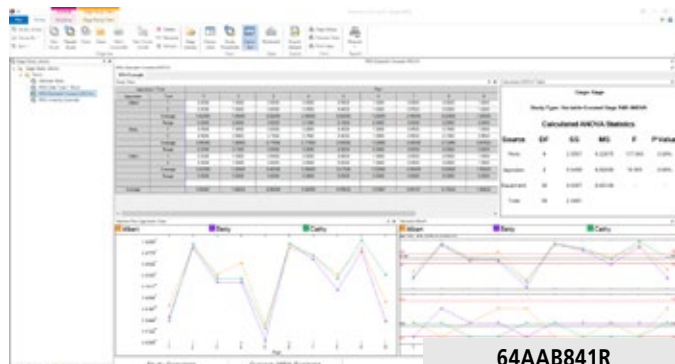

64AAB841R

~~€ 1.144~~ € 859,00
PROMO PRICE

ML Workgroup License V10

15 Licenses

64AAB844R **64AAB844FR**

~~€ 12.605~~ € 9.999
PROMO PRICE

~~€ 6.292~~ € 4.999
PROMO PRICE

Floating license

Also available:

10 Licenses

64AAB846R **64AAB846FR**

~~€ 9.142~~ € 7.349
PROMO PRICE

~~€ 4.576~~ € 3.669
PROMO PRICE

Floating license

Also available:

5 Licenses

64AAB847R **64AAB847FR**

~~€ 5.720~~ € 4.599
PROMO PRICE

~~€ 2.871~~ € 2.299
PROMO PRICE

Floating license

Also available:

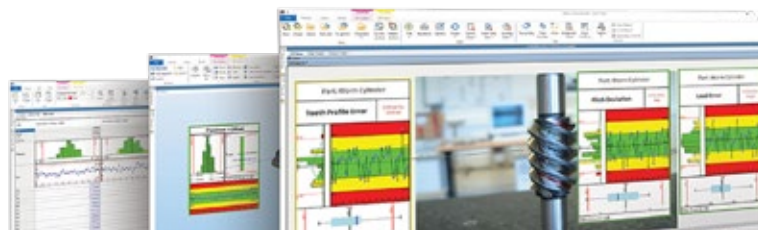

Profile Projectors



For more details, please scan the QR code.

For non-contact measurement, inspection, and observation, especially useful for small, deformable, or fragile parts.

- > Observe surface profiles or inspect minute assemblies with surface illumination.
- > Wide selection of accessories for your measurement and inspection task.
- > Install and operate in a wide range of environments from inspection rooms to manufacturing and processing sites.

PJSET01	
€ 14.227,70	€ 11.999 PROMO PRICE

PJ-P2010A Set

10X objective lens included

200 x 100 mm XY stage with integrated linear scales and quick-release for fast table movements



High Visibility Digital Display



Stepless Illumination Adjustment

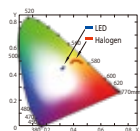

STABLE COLOR TEMP.



FANLESS



LED



Opti-fix Set Basic

12pcs

K550892

~~€ 498,00~~

€ 459,00
PROMO PRICE



M2 Software for Profile Projectors

Main features:

- > Measure, construct, and define 2D features.
- > Part program teach-in.
- > Comprehensive measurement reports.
- > Tolerance check according to DIN / ISO.

M2 sets consists of:

- > M2 metrology software.
- > 2-axis interface box and 15-pin connecting cables.
- > Power supply and USB cable.
- > Machine bracket, RAM ball, RAM arm, VESA mount (75x75) for mounting the optional tablet PC to the projector body.
- > Asus AiO PC for M2.
- > M2SET02 with "EdgeLogic™".

M2SET01

~~€ 2.924~~

€ 2.699
PROMO PRICE

M2SET02

~~€ 4.363~~

€ 3.959
PROMO PRICE

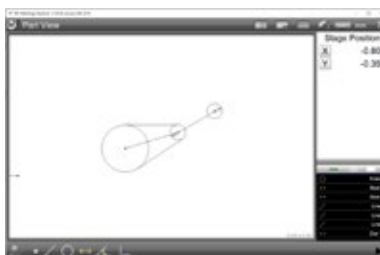

M2 Software



M2 with edge detection unit "EdgeLogic™"

+

Advanced crosshair probe toolbox

Available crosshair probes consist of "auto edge" and "simple" versions that can be used with optical edge enabled systems. Made for capturing points from edges automatically upon crossing, the auto edge probe significantly increases measurement throughput. For optical edge systems only, a key feature of the M2 software, "EdgeLogic™", makes it possible to enable gesture-driven control of start and end measurement commands. You can now start and finish your measurements quickly and easily, without the need for direct interaction with the software.



ASUS AiO PC for M2 system

Accessories

	Products	293-140-40	293-230-30	293-666-20	500-161-30	500-716-20	550-207-10	552-306-10
		293-141-40	293-231-30	293-667-20	500-158-30	500-717-20		
		293-142-40	293-232-30	293-668-20	500-162-30	550-331-20		
		293-143-40	293-233-30	422-411-20	500-205-30	551-331-20		
			293-234-30			571-252-20		
			293-963-30					
			323-250-30					
			323-251-30					
			331-251-30					
			342-271-30					
			422-230-30					
			422-231-30					
Accessories								
264-020	USB Input Tool Interface Box	✓	✓	✓	✓	✓	✓	✓
905338	Digimatic Cable, Flat Straight Type							
905409	Digimatic Cable, Flat Straight Type							
959149	Digimatic Cable, Straight, Data Button,				✓		✓	
959150	Digimatic Cable, Straight, Data Button,				✓		✓	
936937	Digimatic Cable, Flat 10-Pin Type							
965014	Digimatic Cable, Flat 10-Pin Type							
05CZA624	Digimatic Cable with Data Button IP Type					✓		✓
05CZA625	Digimatic Cable with Data Button IP Type					✓		✓
05CZA662	Digimatic Cable with Data Button IP Type		✓	✓				
05CZA663	Digimatic Cable with Data Button IP Type		✓	✓				
06AGL011	Digimatic Cable, Straight, 1m							
06AGL021	Digimatic Cable, Straight, 2m							
06AGL111	Digimatic Cable with Data Button IP Type	✓						
06AGL121	Digimatic Cable with Data Button IP Type	✓						
06AFM380A	USB Input Tool Direct (Digimatic to USB)					✓		✓
06AFM380B	USB Input Tool Direct (Digimatic to USB)		✓	✓				
06AFM380C	USB Input Tool Direct (Digimatic to USB)				✓		✓	
06AFM380D	USB Input Tool Direct (Digimatic to USB)							
06AFM380E	USB Input Tool Direct (Digimatic to USB)							
06AFM380F	USB Input Tool Direct (Digimatic to USB)							
06AFM380G	USB Input Tool Direct (Digimatic to USB)							
06AGQ001A	USB Input Tool Direct (Digimatic to USB)	✓						
06AGQ001F	USB Input Tool Direct (Digimatic to USB)							
06ADV384	USB Input Tool Direct	✓	✓	✓	✓	✓	✓	✓
937179T	Footswitch for SPC	✓	✓	✓	✓	✓	✓	✓
02AZD810D	U-WAVE-R Wireless Receiver	✓	✓	✓	✓	✓	✓	✓
264-620	U-WAVE fit, IP67 Type				✓	✓		
264-621	U-WAVE fit, Buzzer Type				✓	✓		
264-622	U-WAVE fit, IP67 Type	✓	✓					
264-623	U-WAVE fit, Buzzer Type	✓	✓					
02AZD880G	U-WAVE-T, Buzzer Type			✓			✓	✓
02AZD730G	U-WAVE-T, IP67 Type			✓			✓	✓
264-624	U-WAVE fit Bluetooth, IP67 Type				✓	✓		
264-625	U-WAVE fit Bluetooth, Buzzer Type				✓	✓		
264-626	U-WAVE fit Bluetooth, IP67 Type	✓	✓					
264-627	U-WAVE fit Bluetooth, Buzzer Type	✓	✓					
02AZF300	Connection Unit for Standard Caliper				✓			
02AZF310	Connection Unit for IP Caliper, Micromet		✓			✓		
02AZF700	Connection Unit for ID-C Indicator							
02AZF960	Connection Unit, IP Micrometer	✓						
02AZD790A	Connection Cable A for U-WAVE							✓
02AZD790B	Connection Cable B for U-WAVE			✓				
02AZD790C	Connection Cable C for U-WAVE						✓	
02AZD790D	Connection Cable D for U-WAVE							
02AZD790E	Connection Cable E for U-WAVE							
02AZD790F	Connection Cable F for U-WAVE							
02AZD790G	Connection Cable G for U-WAVE							
02AZG011	Connection Cable SF for U-WAVE							
21EZA198	Spindle Lifting Lever							
21AZB149	Spindle Lifting Lever							
21JZA295	Spindle Lifting Cable							
21EZA099	Remote Controller							
7822	Contact Element Set, M2,5x0,45							
264-505D	Statistic Processing Printer DP-1VA	✓	✓	✓	✓	✓	✓	✓

✓ Indicates that the accessory is compatible
with the product or product group.

2046A	543-781B-10	543-700B	543-855B-D	543-720B	543-561D	468-981	570-402	HR-530	HR-320 / 430	
2046AB	543-791B-10	543-710B		543-730B	543-563D	468-982	570-404	810-233-33	810-192-31	
2046AB-60	511-925-20			543-851D		468-983	570-414	810-333-33	810-193-31	
	543-300B-10			543-853D		468-984	192-615-10		810-194-31	
						468-985				
										Page No.
	✓	✓	✓	✓	✓	✓	✓	✓		23
	✓						✓			24
	✓						✓			24
										24
										24
						✓		✓		24
						✓		✓		24
										24
										24
						✓				24
						✓				24
		✓	✓	✓						24
		✓	✓	✓						24
										24
										24
										24
							✓			25
										25
						✓				25
										25
	✓								✓	25
								✓		25
										25
		✓	✓	✓						25
	✓	✓	✓	✓	✓	✓	✓	✓	✓	25
	✓	✓	✓	✓	✓	✓	✓	✓	✓	25
	✓	✓	✓	✓	✓	✓	✓	✓	✓	26
										26
										26
	✓	✓	✓	✓						26
	✓	✓	✓	✓						26
						✓		✓	✓	26
						✓		✓	✓	26
										26
										26
										26
										26
										26
	✓	✓	✓	✓						26
	✓	✓	✓	✓						26
										26
		✓								27
										27
										27
										27
										27
										27
										27
										27
	✓									27
✓				✓	✓					27
✓				✓						27
✓	✓	✓	✓							17
										17
										17
										17
✓	✓	✓	✓	✓	✓	✓	✓	✓	✓	18
	✓	✓	✓	✓	✓	✓	✓	✓	✓	23

Action valid from November 1, 2024 until January 31, 2025. We reserve the right to make technical changes and developments; these prices only apply to business customers; all prices are understood to be net prices in EURO + VAT -further information is obtainable from www.mitutoyo.eu. Delivery and prices of products offered herein are valid while supplies last. Technical changes, mistakes, and printing errors excepted.



Whatever your challenges are, Mitutoyo supports you from start to finish.

Mitutoyo is not only a manufacturer of top-quality measuring products, but also one that offers qualified support for the lifetime of the equipment backed up by comprehensive services, ensuring your staff can make the very best use of the investment.

Apart from the basics of calibration and repair, Mitutoyo offers product and metrology training, as well as IT support for the sophisticated software used in modern measuring technology. We can also design, build, test, and deliver bespoke measuring solutions and even, if deemed cost-effective, take your critical measurement challenges in-house on a sub-contract basis

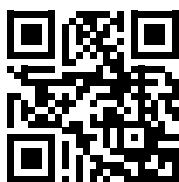

Find additional product literature and our complete catalog here.

www.mitutoyo.eu

Note: Product illustrations are without obligation. Product descriptions, in particular any and all technical specifications, are only binding when explicitly agreed upon. MITUTOYO, ABSOLUTE, DIGIMATIC, OPTOEYE and U-WAVE are either registered trademarks or trademarks of Mitutoyo Corp. in Japan and/ or other countries/regions. Opti-fix is a registered trademark of KOME G Industrielle Meßtechnik GmbH. Excel, Microsoft, and Windows are either registered trademarks or trademarks of Microsoft Corporation in the United States and/ or other countries. Thiokol is a registered trademark of TORAY FINE CHEMICALS Co., Ltd. TÜV is a registered trademark of (among other holders) TÜV Rheinland AG. YouTube is a registered trademark of Google Inc. Other product, company and brand names mentioned herein are for identification purposes only and may be the trademarks of their respective holders



Mitutoyo Europe GmbH

Borsigstraße 8-10
41469 Neuss

Tel. +49 (0) 2137-102-0

info@mitutoyo.eu
www.mitutoyo.eu