

CNC Vision Measuring System QUICK VISION Pro Series



Evolutionary Advancement

Highly Advanced Non-contact Measurement Technologies

Well-designed main unit structured for high-accuracy measurement and autofocus.
Integration of these high-performance technologies has made 3D non-contact measurement a reality.
The QUICK VISION Pro, our CNC vision measuring machine family, never stops evolving.



Enables High-Throughput Measurements Required for Vision Measuring Systems

In recent years, the technology surrounding our lives has entered a period of substantial change. Daily updates and technological innovations in motorized vehicles, 5G communications, and IoT technologies are evolving with unprecedented speed.

The QUICK VISION Pro was developed to keep pace with these technological innovations and industrial challenges. Experience the high-throughput non-contact measurement that Mitutoyo offers.

MEDICAL

— Three unique industries benefiting from Mitutoyo's high reliability. «Medical»

Ultra-small

Medical devices requiring high accuracy

Medical devices directly affect people's health and life. Therefore, every part requires strict adherence to demanding accuracy specifications. The lens and forceps of an endoscope, for example, are installed in a tip with a minimum diameter of 3 mm. With a maximum of 4,300X magnification, various types of autofocus, and high-resolution edge detection, the QUICK VISION Pro allows you to measure objects without making contact for applications that require accuracy at the most minute level. Its improved repeatability and enhanced technical measurement capabilities adhere to the most stringent global standards.

To respond to the demands of emergency medical care, medical devices need to sustain more requirements. Through improving our measurement technologies in the manufacture of medical devices, Mitutoyo is committed to contributing to the advancement of medical technology.

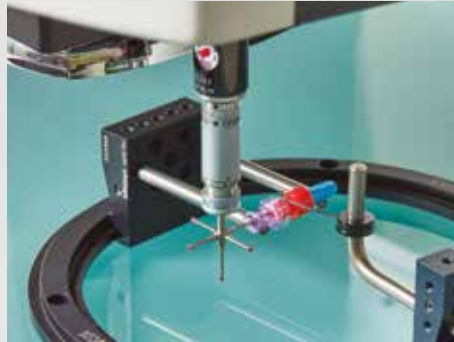

Example of measuring a valve used in medical equipment





Optimized optical system for ultra-small dimensional measurement

By combining ten different objective lenses with a built-in imaging lens, a maximum of 150X optical magnification (4,300X total on-monitor magnification) can be achieved. This enables measurement of ultra-small parts, such as medical device components.

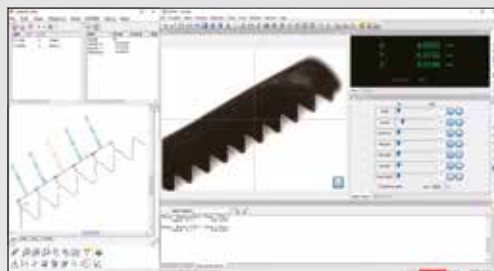

Example of image measurement of medical forceps

High-accuracy 3D measurement

High-accuracy height measurement using single-focus high-resolution images and PFF (Points From Focus) enable 3D capturing of the object shapes, thereby expanding the scope of measurement.

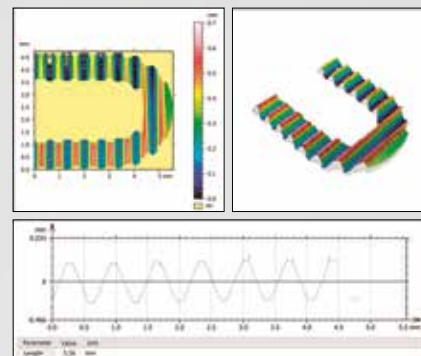

3D analysis of the shape captured by PFF and analyzed with MCubeMap

AUTOMOTIVE

— Three unique industries benefiting from Mitutoyo's high reliability. «Automotive»

Cutting-edge

Flexible measurement of new parts for electric vehicles

With the increasing demand for reducing greenhouse gas emissions, automobile production is shifting from petrol and diesel vehicles to electric vehicles, shifting the key automotive parts to now change to electric motors, batteries, and semiconductors at an increasingly rapid rate.

The QUICK VISION Pro is optimal for use in the manufacturing processes of, for example, pre-stacking motor core parts that are thin and difficult to touch for measurement, fuel cell separators that have minute surface irregularities and require precise measurement, and semiconductor parts of inverters that require high-speed measurement of microscopic features.

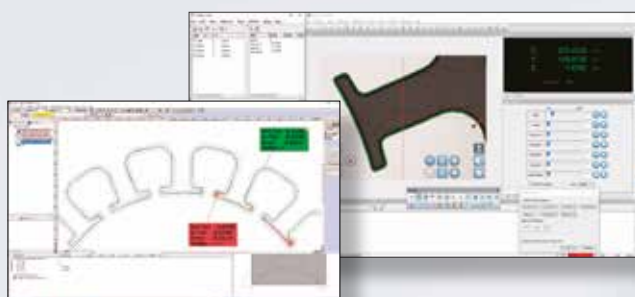

Tolerancing example

Meeting the rigorous quality control standards of the automobile industry

The introduction of CASE technologies will drive demand for electronic and semiconductor parts in the automotive industry. QUICK VISION Pro offers quality control within the automobile industry by providing both contact and non-contact technologies.



Example of measuring an engine control unit

Enabling online programming using 3D CAD models

In addition to online programming using 3D CAD models, an offline program can be created from an image or with a touch probe. This makes it possible to increase the up-time of the QUICK VISION Pro main unit, thereby shortening production lead times.

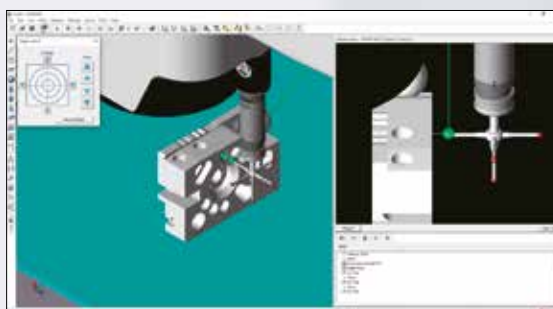

Online programming using 3D CAD models

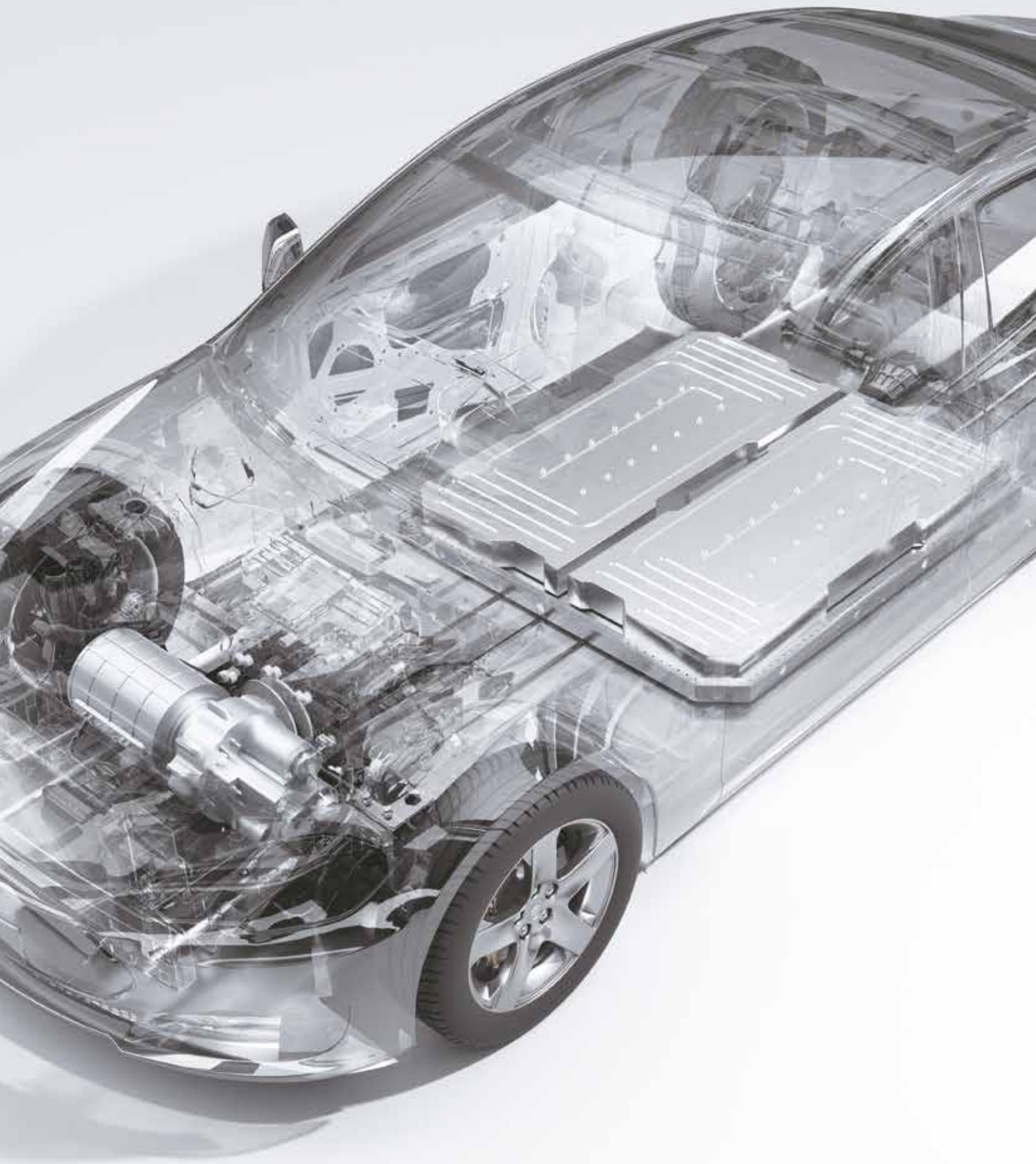

SEMICONDUCTOR

— Three unique industries benefiting from Mitutoyo's high reliability. «Semiconductor»

Full automation

Continuous measurement during mass production

The shift of production to electric vehicles, expansion of services promoted by commercialized 5G, and recovery of capital investment in data centers are all growing signs of recovery in the semiconductor market. The market is expected to show more growth and will be prepared for mass production to meet increasing demand. QUICK VISION Pro synchronizes main unit operation with the strobe of the camera used for measuring, therefore providing high-speed measurements to enhance the productivity of semiconductor manufacturing. For example, the stage keeps moving without stopping while the system measures many features on the shower head to check for dimensional errors or foreign substances, which can significantly reduce the cycle time.

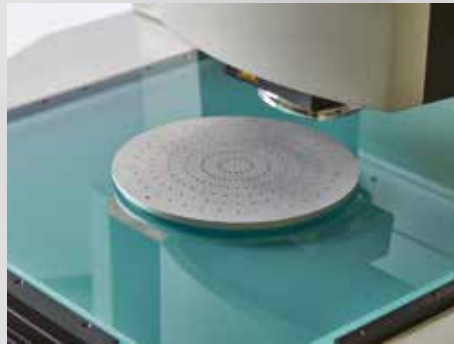

See video from here



Preventing nonconformities during mass production

Continuous measurement by STREAM and quick focusing by TAF can deliver high-speed measurements. This prevents non-conforming final products by increasing the number of features measured.



3D measurement with multiple sensors

Surface texture and cross-section can be analyzed by combining vision measurement, the non-contact displacement sensor (laser or chromatic position sensor), PFF (Points From Focus), and WLI (White Light Interferometer).

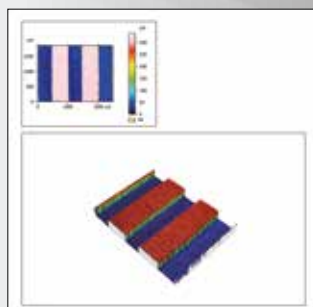

Flaw Inspection Software DDPAK-QV

DDPAK-QV, defect detection software, allows for detection of contaminants, burrs, cracks, etc., in addition to dimensional measurement. Flaws can be found that cannot be detected by typical dimension measurement.

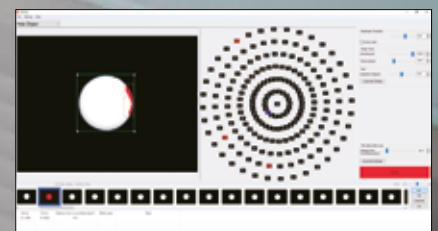

Inspection for foreign substances in shower head diameters

QUICK VISION

HYPER

HYBRID

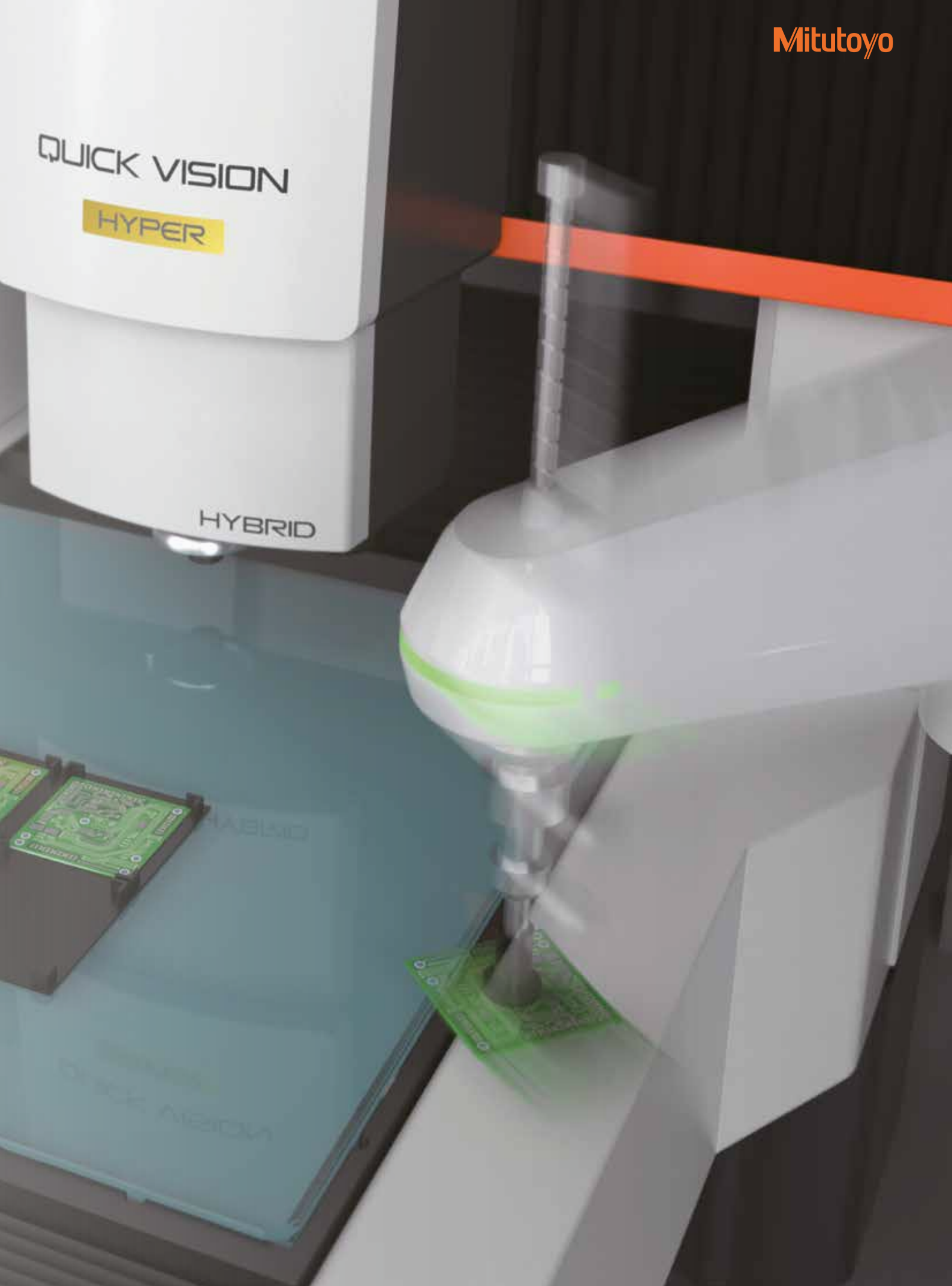

APPLICATION

Example of non-stop measurement by STREAM

The high-throughput measurement of QUICK VISION Pro is suitable for measuring position information in the RDL process for semiconductor package FO-PLP. Moreover, extensive IO software (optional) means you can easily incorporate automation, such as automatic transfer of workpieces with a SCARA robot, etc.

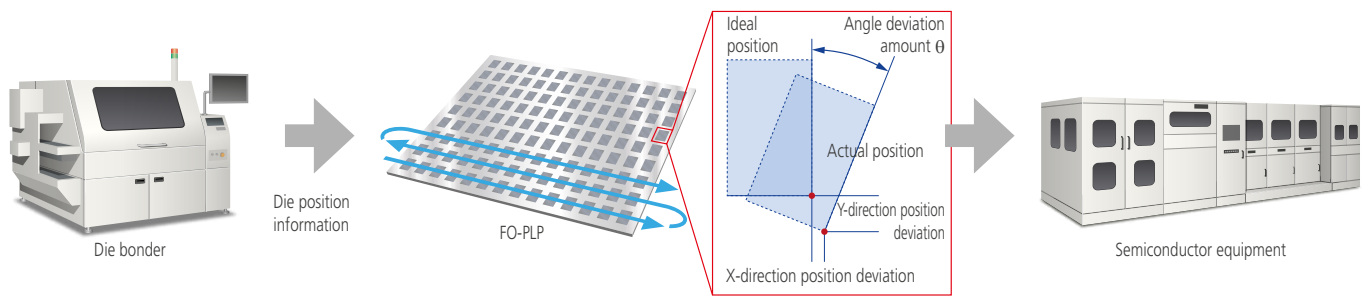
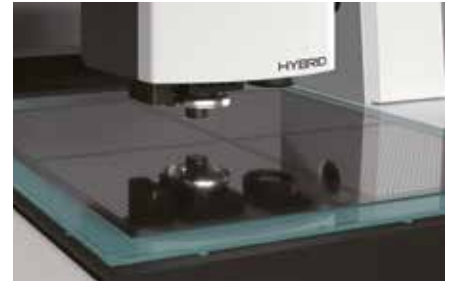

Example of Z-axis tracking high-throughput measurement

QUICK VISION Pro can deliver high-speed and high-efficiency edge detection, due to the newly developed StrobeSnap function. By utilizing the TAF (Tracking Autofocus), it can deliver high-speed measurement of an edge that fluctuates in the vertical direction, by tracking the surface automatically.

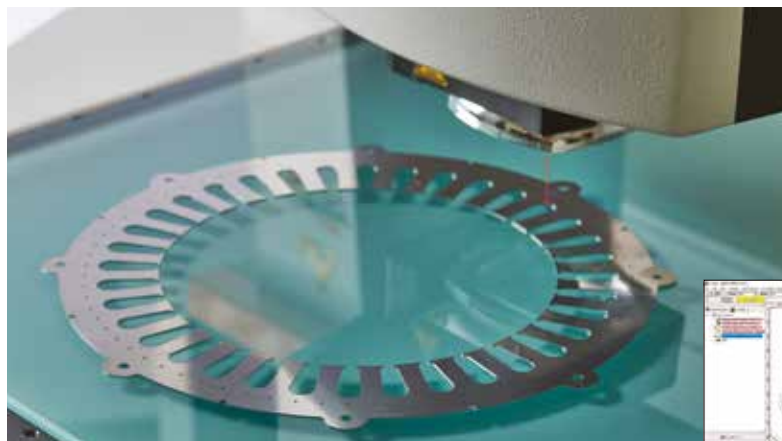

Contour measurement of motor cores for EV

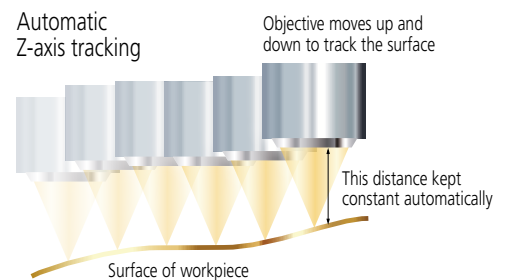

Tolerancing example



See video from here

Example of ultra-small 3D shape dimension measurement

QUICK VISION Pro can obtain ultra-small shape dimensions in 2D/3D, due to a wide variety of sensing technologies, such as PFF, WLI, and CPS. For example, when measuring the features of a multilayer board, including wiring line & space, via diameter, and surface roughness measurement, the QUICK VISION Pro can take measurements and analyze 3D shapes by using the white light interferometer.

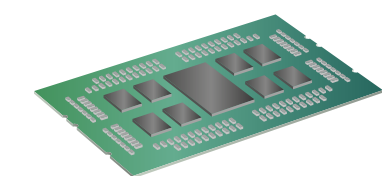

Flip-chip IC package board

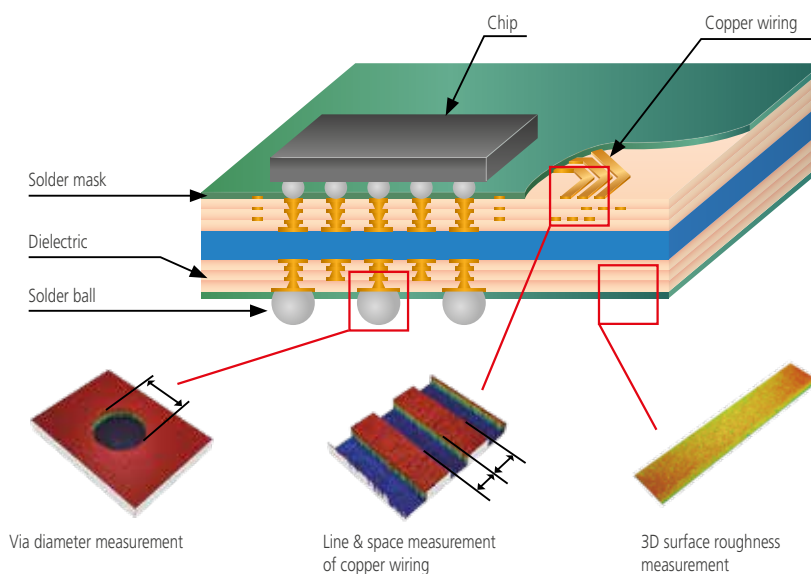

Example of measuring medical device components

When measuring "Medical" components of ultra-small dimensions requiring high "reliability" QUICK VISION Pro is very effective when it comes to ultra-small workpieces, due to a wide variety of objective lenses. Therefore, even a fine contour that is difficult for conventional contact-type measuring instruments can be measured by PFF, which performs 3D measurement based on image contrasts, and CPS (non-contact displacement sensor).

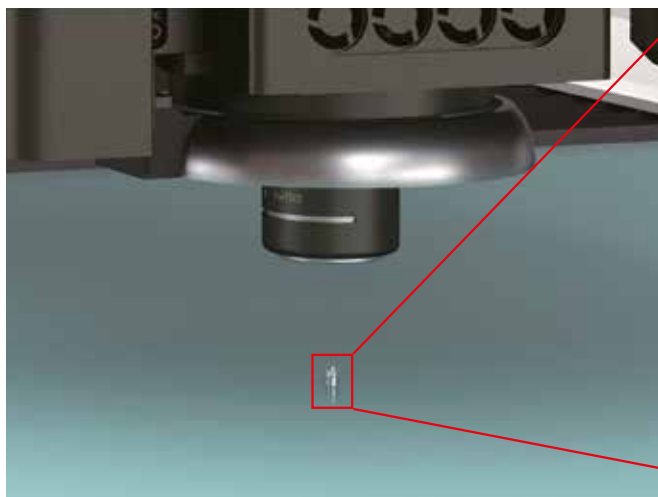

Endoscope component



Medical forceps

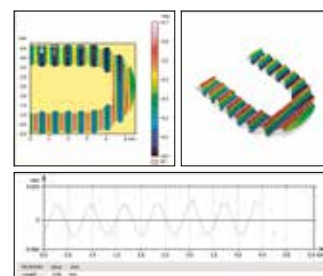

3D shape measurement by PFF

TECHNOLOGY

Rich functionality supporting various kinds of measurement

The QUICK VISION Pro achieves the high-level integration of the measurement technologies that Mitutoyo has developed over the years. By combining standard objective lenses, special software (QVPAK), and various optional sensors, the QUICK VISION Pro provides a wide range of functions to support various kinds of measurement. While meeting the growing requirements of measurement environments, it continues to improve these functions, strongly supporting solutions to any challenge.

1 StrobeSnap

A magnified image captured through the optical lens is displayed on a PC screen. Various functions including edge detection and autofocus can be used for dimensional measurement (common to all models).

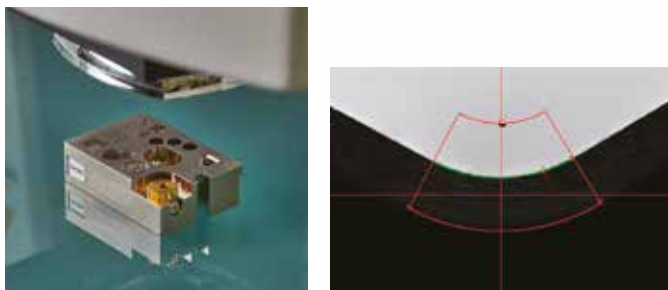

2 Measuring a 3D object without moving it Touch-Trigger Probe

By also using the touch-trigger probe, the system can capture a 3D object by measuring its sides at a given height without rotating it, something that is difficult with the camera alone.



3 Non-contact measurement of steep angle surfaces and transparent objects CPS Probe

Differences in the focal length of white light are used to measure an angled surface. Additionally, the thickness of a thin, transparent object is measured by simultaneous detection of surface heights at two points on the object.

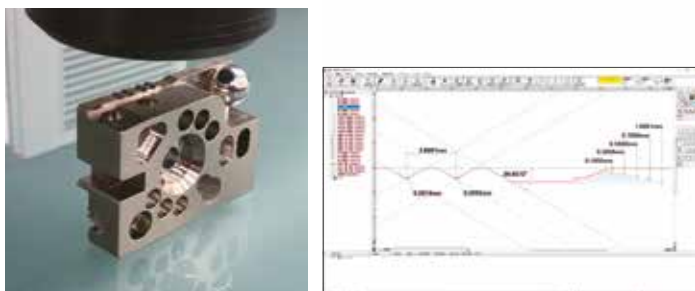

4 Capturing microscopic features of a 3D object using white light interference White Light Interferometer

Using the white light interference that occurs between the system and the object, the system performs high-accuracy 3D measurement for surface texture analysis (roughness, etc.) and shape measurement (irregularities of several μm) in a minute area.

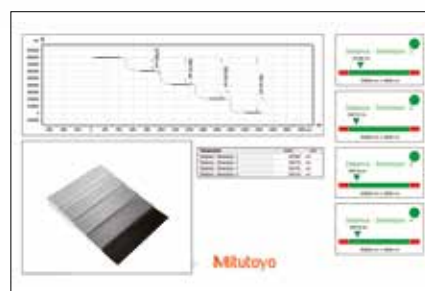

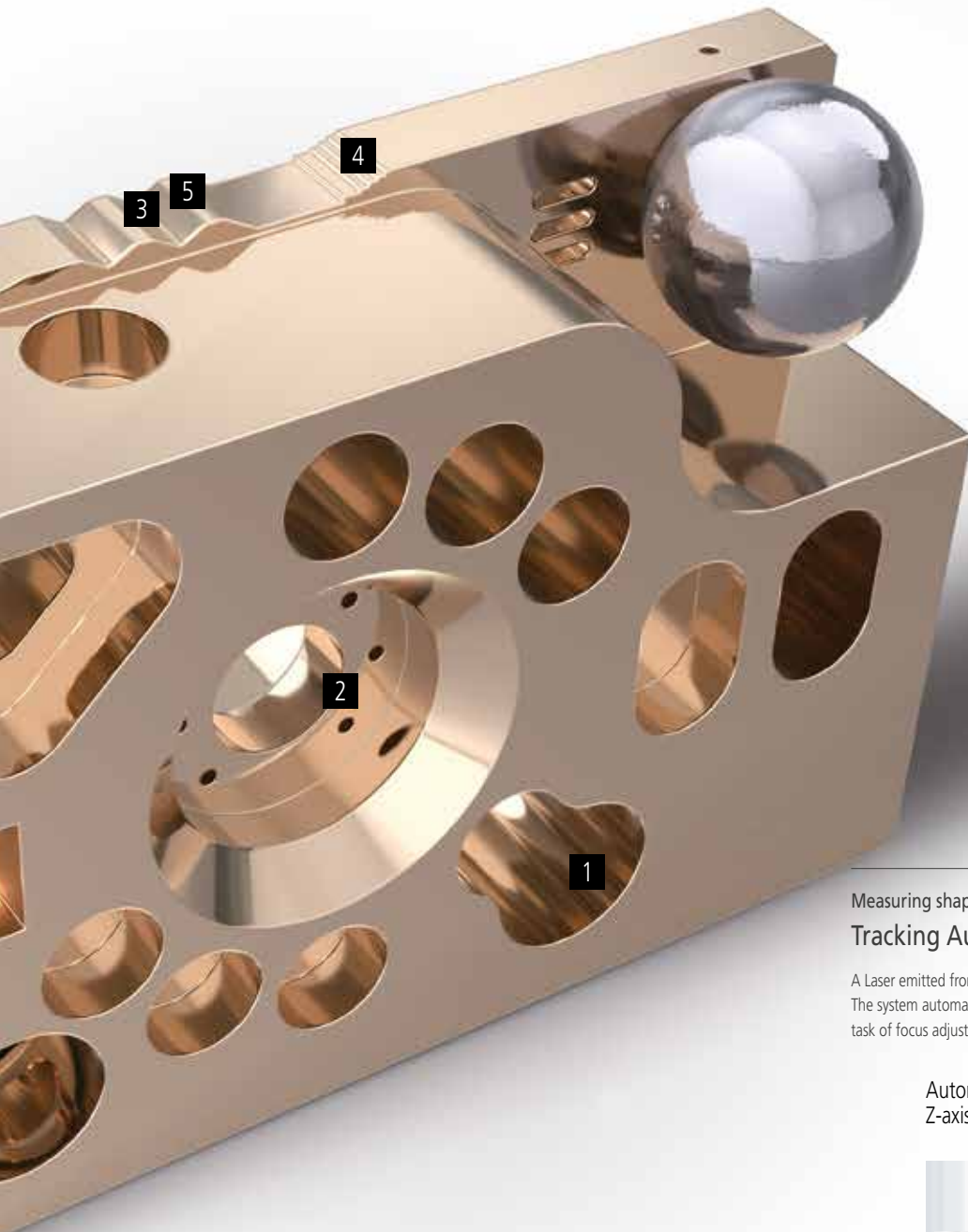

Measuring shapes of all kinds of objects
Tracking Autofocus (TAF)

A Laser emitted from the objective lens enables automatic focusing. The system automatically keeps the object in focus according to its shape, eliminating the task of focus adjustment and increasing measurement throughput.

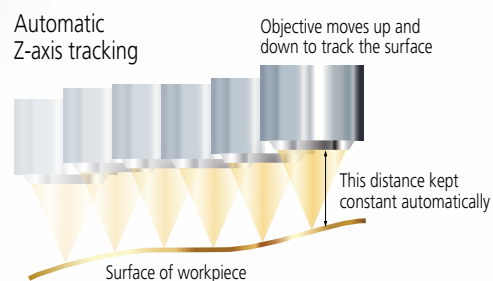

5 3D measurement with multiple cross-section images
PFF (Points From Focus)

Scanning the object by auto-focusing the objective lens can capture multiple cross-section images (image contrasts) at different heights. Thus obtaining 3D shape data from such images.

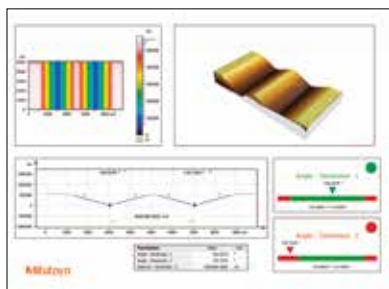

High-speed non-contact measurement of minute height difference and curved shape
Laser Probe

The laser confocal sensor, less affected by the color of the object, can scan surfaces. The sensor scans the object to capture the surface shape data in a non-contact manner.

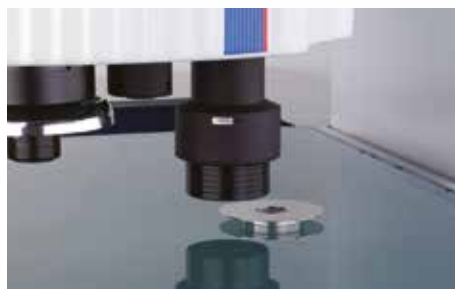

Simple measurement procedure
QV Index

The indexing table turns the object to enable automatic measurement of multiple surfaces in a single setup.



QUICK VISION Pro core functions providing high-throughput measurement

The observation unit and the lighting unit of QUICK VISION Pro have been updated, increasing the measurement throughput by about 40% compared with conventional models. Furthermore, measurement programming in two modes has made it possible to conduct high-throughput measurements of any measurement sample. TAF and high-speed autofocus provide amazingly high throughput even for measurement samples of varying heights.

StrobeSnap

All the QUICK VISION Pro models are equipped with a strobe light, and the newly developed vision measuring function "StrobeSnap" delivers measurements with both high throughput and high accuracy. Regardless of the continuity of measuring positions, measuring time can be shortened by about 35 to 45% for most measurement samples. The excellent compatibility with part programs allows a part program to be created for high-speed measurement with ease.



See video from here

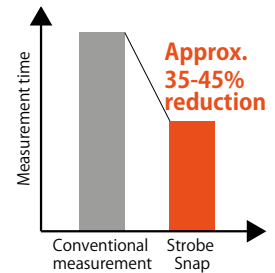
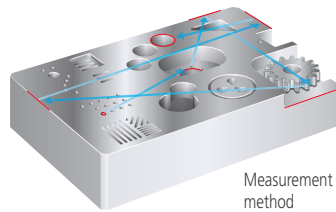

Note: Comparison with old specifications using our demo sample

STREAM function (optional)

The STREAM function provides an amazingly high throughput, due to the non-stop measurement where the camera motion and the strobe light are synchronized. It can shorten measuring time more than StrobeSnap on account of continuous element measurement as shown in the following conceptual image of measurement.

The STREAM function of QUICK VISION Pro, including the HYPER model, can be upgraded as an option.



See video from here



XY=0.2 mm pitch, 626 elements
Measured with a field of view of 0.62x0.47 mm
STREAM measurement 36 sec.

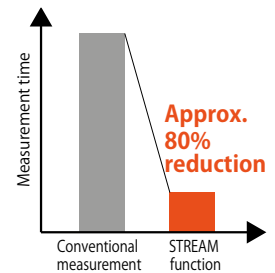
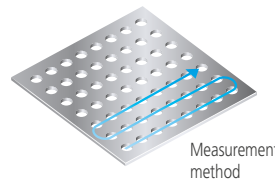

Note: Comparison with old specifications using our demo sample

Tracking Autofocus (TAF)

Height change in a workpiece can be quickly tracked in the Z-axis direction via laser. StrobeSnap and STREAM allow it to perform effectively, resulting in a significant increase of measurement throughput.



See video from here

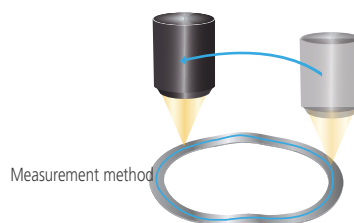
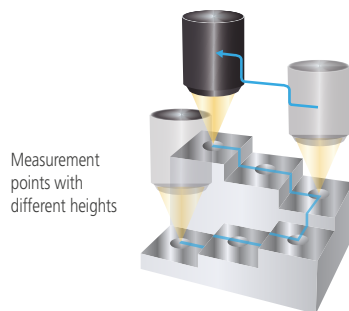

High-performance image autofocus

The image autofocus of QUICK VISION Pro can measure the height of mirror-finished surfaces through to rough surfaces, such as machined surfaces and plastic molded parts, with high accuracy and at high speed under any conditions. Image autofocus speed has been improved by about 30% compared with conventional models.

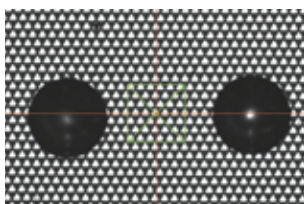

Pattern focus

By projecting a pattern through the optical path, autofocus can be applied to even surfaces on which it is difficult to obtain contrast, such as glass surfaces, film surfaces, and mirror-finished surfaces used widely for semiconductor parts.



IC package

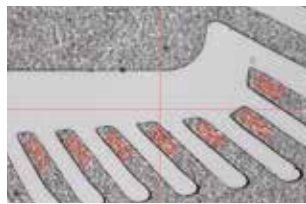

Multi-point autofocus

Multi-point autofocus can be used to set multiple focus positions, sizes, and angles to independent locations. This tool can be used to obtain multiple sets of height information with a single focus operation, which makes it possible to perform highly efficient height and flatness measurements.

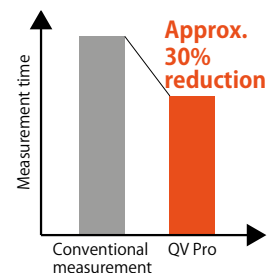

Note: Comparison with old specifications using our demo sample

Highly Functional Illumination Unit

- QUICK VISION Pro uses LEDs for all of its light sources: contour, surface, and programmable ring light.
- Lighting uniformity has been achieved at a high level, which leads to excellent part program compatibility between multiple QUICK VISION machines.
- LED light sources have excellent responsiveness, which improves measurement throughput.
- LED light sources have longer life spans than halogen types, which reduces illumination fluctuations and thereby minimizes any errors caused by changes in light intensity.



Surface illumination

Programmable ring light illumination

Contour illumination

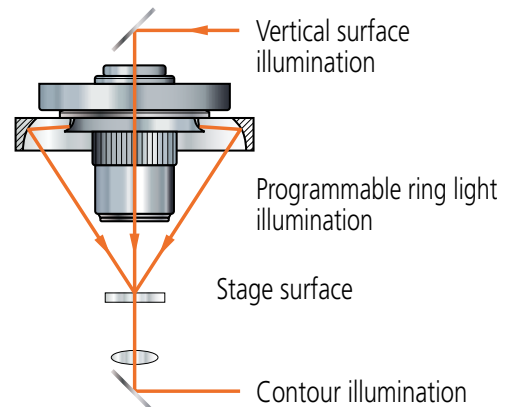

Programmable Ring Light (PRL)

Changing the positions of the two curved mirrors sets the ring light's direction to any chosen value between 30° and 80°. This is effective for enhancing the edges of inclined surfaces or very small steps. Furthermore, the PRL's illumination can be controlled independently in every direction, front and back, right and left. This makes it possible to configure highly variable lighting settings to match measurement locations.



White LED illumination/Color LED illumination

With QUICK VISION Pro, white LED lighting is standard with optional colored surface and ring light LED lighting available. The colored LED model can emphasize edge contrast by changing the emitted light color.

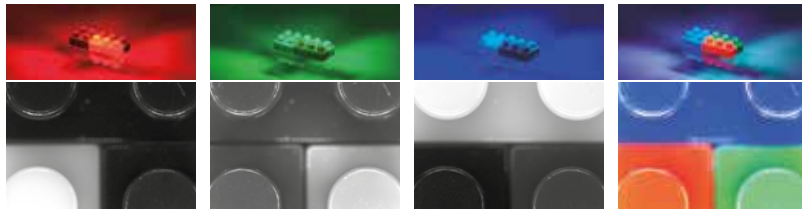

Using the pseudo-color image display function generates a color observation image with high color reproducibility from each of the RGB-irradiated images.



See video from here

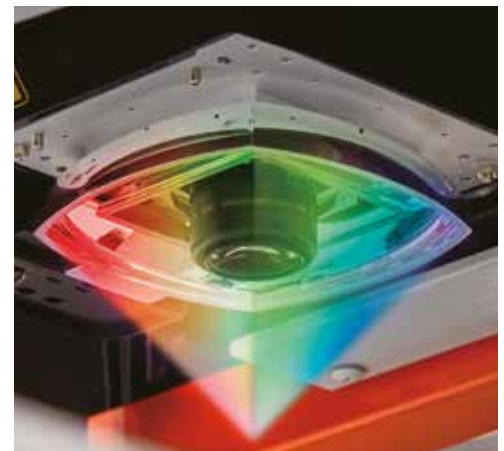

Note: This is a conceptual image of the colored LED illumination model.

Programmable Power Turret

QUICK VISION Pro's programmable power turret has excellent magnification repeatability which makes it suited for highly accurate measurements. The standard specification permits three steps of magnification: 1X, 2X, and 6X*.

The rich lineup of objectives includes lenses with magnifications ranging from 0,5X to 25X, which makes it possible to select the optimal optical system to match the measurement target. It is possible to install additional objectives after the purchase of the main unit.

* Also available as special options: three or four steps of magnification: 1X, 2X, and 4X; or 1X, 2X, 4X, and 6X.

When using QV-HR1X

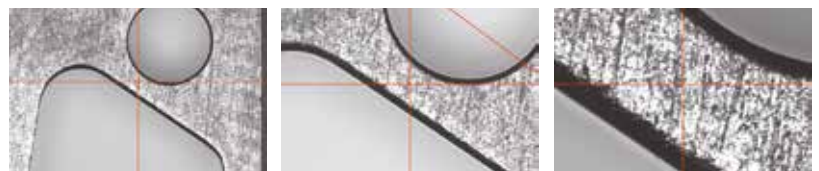

Turret 1X Field of view: 6,27x4,70 mm

Turret 2X Field of view: 3,13x2,35 mm

Turret 6X Field of view: 1,04x0,78 mm

When using QV-HR10X



Turret 1X Field of view: 0,62x0,47 mm

Turret 2X Field of view: 0,31x0,23 mm

Turret 6X Field of view: 0,10x0,07 mm

Well-designed structure for high-accuracy measurement

The main unit utilizes a moving Y-axis table with a fixed bridge. Structural deformation caused by movement along each axis has been minimized, which ensures that the QUICK VISION Series can be used to perform highly accurate measurements with minimal spatial coordinate distortions.

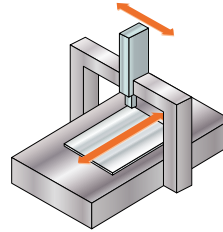

Equipped with thermal compensation function

Each QUICK VISION Pro model is equipped with the thermal compensation function.

- APEX Manual Input from software
- HYPER Automatic Real-time automatic input from X/Y/Z-axis scale and workpiece temperature sensor

Accuracy guaranteed temperature (1) 20±2 °C (2) 19 to 24 °C as seen in (1) and (2), accuracy can be guaranteed across a wide range of temperature conditions.

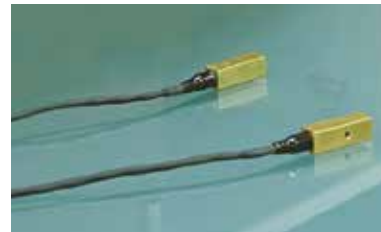

Temperature compensation sensor

Accuracy-guaranteed performance, complying with the MPE notation that includes inspection uncertainty

- QV APEX Pro/QV HYPER Pro
- QVTP APEX Pro/QVTP HYPER Pro
- QVH4 APEX Pro/QVH4 HYPER Pro

Compliance with EN ISO 10360-7:2011 (optional)

The unit complies with the accuracy guarantee of EN ISO 10360-7:2011. Whether performing vision measurement or touch probe measurement, you can measure even spatial position dimensions (including height) with no issues. For applicable models, see the specs of each model on pages 18 to 22.

Accuracy guarantee items

- Length measurement error $E_{L, MPE}$
- Probing error $P_{P2D, MPE}$

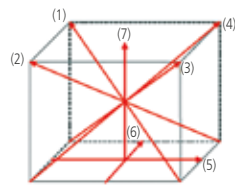

Length measurement error $E_{L, MPE}$

What is true traceability?

Adopting reference instruments traceable to the national standard

To build customer trust, we adhere to traceability to the national standard.

- Mitutoyo's calibration artifacts and instruments that are used to establish machine accuracy specifications are maintained in a continuous chain of traceability to national dimensional standards. This is our customers' assurance of reliable measurement.
- Our calibration service provider is JCSS certified by IAJapan, which is a certifying body internationally accredited by ILAC in accordance with MRA (Mutual Recognition Arrangement). It has been qualified for measurement techniques equivalent to those of international calibration organizations.

Note: The chart on the right shows an outline of traceability for the vision measuring machine.

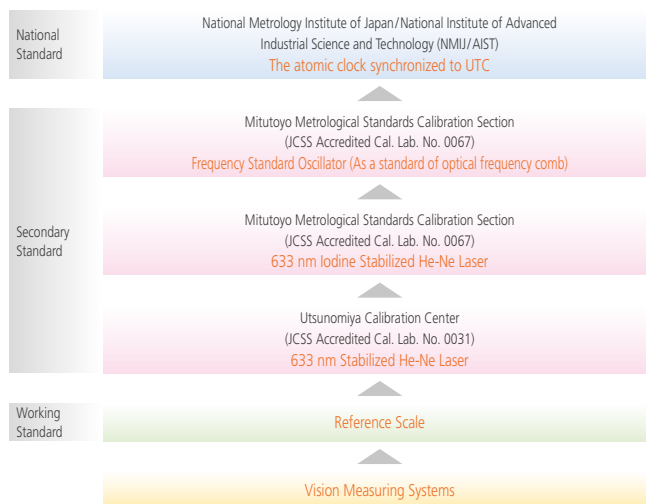

LINE-UP

A wide array of variations and systems available to broaden measurement applications and improve quality control.

The QUICK VISION Pro offers a rich lineup with a wide array of measurement ranges and accuracies useful for implementing quality control in all industries, including medical, automotive, electronics, and semiconductors. It expands measurement applications by combining a vision measuring system that optically magnifies an object image with multiple sensors, including non-contact probes, touch probes, and a white light interferometer.

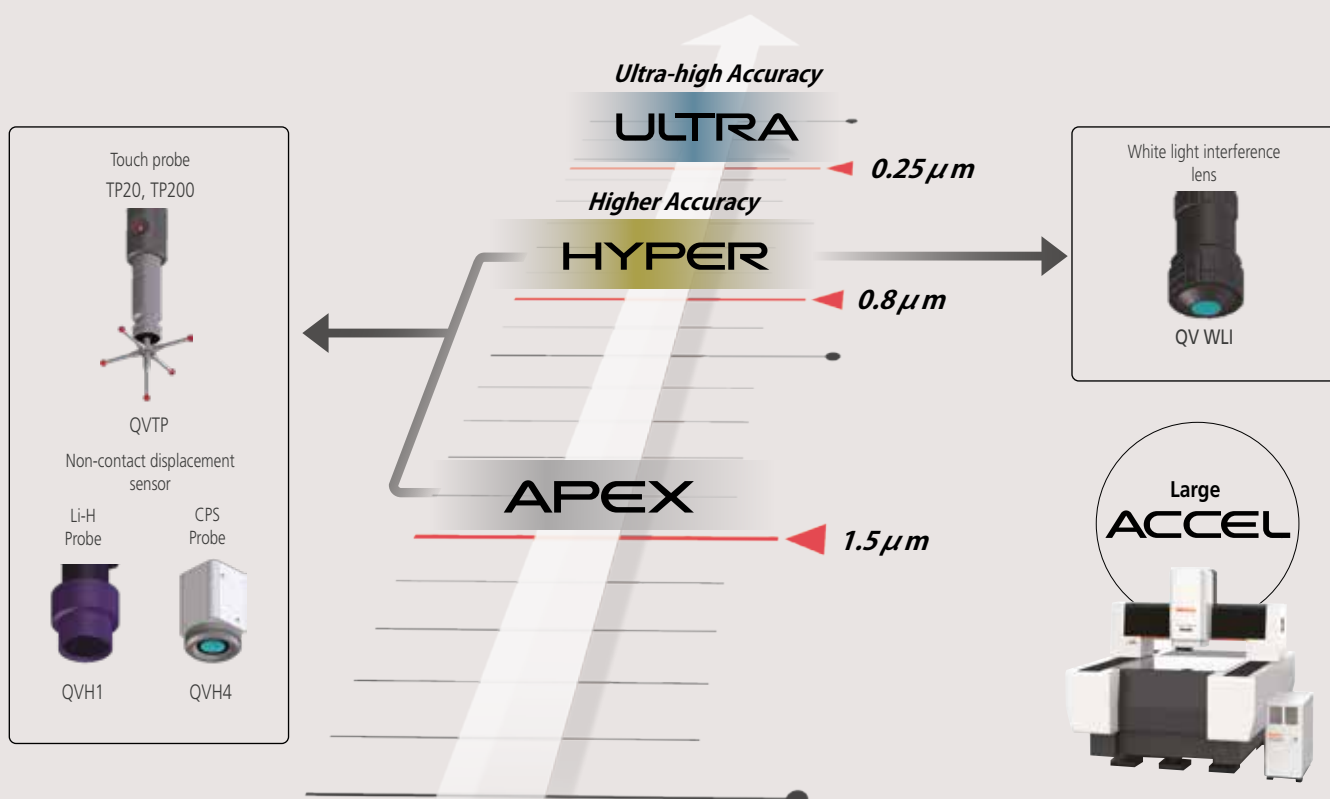



QV APEX Pro

CNC Vision Measuring System



- This is a superior model of QUICK VISION, which is equipped with the StrobeSnap function as standard, enabling high-speed measurement.
- We offer a model with Tracking Auto Focus (TAF) that quickly focuses on the object improving throughput significantly.
- The camera motion and the strobe light are synchronized to make non-stop vision measurements without stopping the stage. This makes it possible to use STREAM to shorten measuring time dramatically.



QV APEX 302 Pro

Model	QV APEX 302 Pro				QV APEX 404 Pro				QV APEX 606 Pro				
Order No.	363-601 QV-X302P1L-E	363-603 QV-X302T1L-E	363-602 QV-X302P1C-E	363-604 QV-X302T1C-E	363-611 QV-X404P1L-E	363-613 QV-X404T1L-E	363-612 QV-X404P1C-E	363-614 QV-X404T1C-E	363-621 QV-X606P1L-E	363-623 QV-X606T1L-E	363-622 QV-X606P1C-E	363-624 QV-X606T1C-E	
Measuring range [mm]	300×200×200				400×400×250				600×650×250				
Observation unit*	Programmable power turret 1X-2X-6X												
TAF	—	✓	—	✓	—	✓	—	✓	—	✓	—	✓	
Illumination unit	White LED												
	Contour illumination		White LED										
	Surface illumination		White LED		Color LED		White LED		Color LED		White LED		Color LED
PRL		White LED		Color LED		White LED		Color LED		White LED		Color LED	
Resolution of scale [μm]	0,1												
Vision measuring accuracy [μm]	E _{UX} / E _{UY} , MPE												
	(1,5 + 3L/1000)												
	E _{UXY} , MPE												
(2,0 + 4L/1000)													
E _{UZ} , MPE													
(1,5 + 4L/1000)													
LAF repeatability [μm]	—	σ≤0,8	—	σ≤0,8	—	σ≤0,8	—	σ≤0,8	—	σ≤0,8	—	σ≤0,8	
Temperature compensation function	Manual												

* Programmable power turret 1X-2X-4X model and 1X-2X-4X-6X model are available to special order

QV HYPER Pro

High-accuracy CNC Vision Measuring System



- The QV HYPER Pro is a highly accurate model that is equipped with a high-resolution/accuracy scale.
- We offer a model with Tracking Auto Focus (TAF) that quickly focuses on the object improving throughput significantly.
- The camera motion and the strobe light are synchronized to make non-stop vision measurements without stopping the stage. This makes it possible to use STREAM to shorten measuring time dramatically.
- There is a general-purpose model with white LED light and an enhanced edge detection model with RGB color LEDs.
- This model is standard-equipped with automatic temperature compensation that uses a temperature sensor on the main unit of the measuring machine and a temperature sensor for the workpiece.



QV HYPER 302 Pro

Model	QV HYPER 302 Pro				QV HYPER 404 Pro				QV HYPER 606 Pro				
Order No.	363-605 QV-H302P1L-E	363-607 QV-H302T1L-E	363-606 QV-H302P1C-E	363-608 QV-H302T1C-E	363-615 QV-H404P1L-E	363-617 QV-H404T1L-E	363-616 QV-H404P1C-E	363-618 QV-H404T1C-E	363-625 QV-H606P1L-E	363-627 QV-H606T1L-E	363-626 QV-H606P1C-E	363-628 QV-H606T1C-E	
Measuring range [mm]	300×200×200				400×400×250				600×650×250				
Observation unit*	Programmable power turret 1X-2X-6X												
TAF	—	✓	—	✓	—	✓	—	✓	—	✓	—	✓	
Illumination unit	White LED												
	Contour illumination		White LED										
	Surface illumination		White LED		Color LED		White LED		Color LED		White LED		Color LED
PRL		White LED		Color LED		White LED		Color LED		White LED		Color LED	
Resolution of scale [μm]	0,02												
Vision measuring accuracy [μm]	E _{UX} / E _{UY} , MPE												
	(0,8 + 2L/1000)												
	E _{UXY} , MPE												
(1,4 + 3L/1000)													
E _{UZ} , MPE													
(1,5 + 2L/1000)													
LAF repeatability [μm]	—	σ≤0,8	—	σ≤0,8	—	σ≤0,8	—	σ≤0,8	—	σ≤0,8	—	σ≤0,8	
Temperature compensation function	Automatic												

* Programmable power turret 1X-2X-4X model and 1X-2X-4X-6X model are available to special order.

QVTP Pro

CNC Vision Measuring System Equipped with a Touch-Trigger Probe



- Non-contact measurement and contact measurement can be done solely by one unit. QVTP Pro can perform contact measurement by using the vision measuring function and the touch-trigger probe.
- Three-dimensional workpiece measurements can be performed. Enables 3D measurement of workpieces such as press-molded products, plastic-molded products, and cut products, which until now could not be measured with image processing alone.
- Using the probe module change rack allows switching between vision measurement and touch-trigger probe measurement during an automatic measuring sequence.



QVTP HYPER 404 Pro

Model		QVTP APEX 302 Pro				QVTP APEX 404 Pro				QVTP APEX 606 Pro			
Order No.		QVT1-X302P1L-E	QVT1-X302T1L-E	QVT1-X302P1C-E	QVT1-X302T1C-E	QVT1-X404P1L-E	QVT1-X404T1L-E	QVT1-X404P1C-E	QVT1-X404T1C-E	QVT1-X606P1L-E	QVT1-X606T1L-E	QVT1-X606P1C-E	QVT1-X606T1C-E
Measuring range [mm]	Vision	300×200×200				400×400×250				600×650×250			
	Common to vision touch probe	234×200×200				334×400×250				534×650×250			
Observation unit*		Programmable power turret 1X-2X-6X											
TAF		—	✓	—	✓	—	✓	—	✓	—	✓	—	✓
Illumination unit	Contour illumination	White LED											
	Surface illumination	White LED	Color LED	White LED	Color LED	White LED	Color LED	White LED	Color LED	White LED	Color LED	White LED	Color LED
Resolution of scale [μm]		0,1											
Vision measuring accuracy [μm]	$E_{UX} / E_{UY}, MPE$	(1,5 + 3L/1000)											
	E_{UXY}, MPE	(2,0 + 4L/1000)											
	E_{UZ}, MPE	(1,5 + 4L/1000)											
TP measuring accuracy [μm]	$E_{X, MPE} / E_{Y, MPE} / E_{Z, MPE}$	(1,8 + 3L/1000)											
Laser autofocus repeatability [μm]		—	$\sigma \leq 0,8$	—	$\sigma \leq 0,8$	—	$\sigma \leq 0,8$	—	$\sigma \leq 0,8$	—	$\sigma \leq 0,8$	—	$\sigma \leq 0,8$
Temperature compensation function		Manual											

* Programmable power turret 1X-2X-4X model and 1X-2X-4X-6X model are available to special order.

Model		QVTP HYPER 302 Pro				QVTP HYPER 404 Pro				QVTP HYPER 606 Pro			
Order No.		QVT1-H302P1L-E	QVT1-H302T1L-E	QVT1-H302P1C-E	QVT1-H302T1C-E	QVT1-H404P1L-E	QVT1-H404T1L-E	QVT1-H404P1C-E	QVT1-H404T1C-E	QVT1-H606P1L-E	QVT1-H606T1L-E	QVT1-H606P1C-E	QVT1-H606T1C-E
TAF		—	✓	—	✓	—	✓	—	✓	—	✓	—	✓
Resolution of scale [μm]		0,02											
Vision measuring accuracy [μm]	$E_{UX} / E_{UY}, MPE$	(0,8 + 2L/1000)											
	E_{UXY}, MPE	(1,4 + 3L/1000)											
	E_{UZ}, MPE	(1,5 + 2L/1000)											
TP measuring accuracy [μm]	$E_{X, MPE} / E_{Y, MPE} / E_{Z, MPE}$	(1,7 + 3L/1000)											
LAF repeatability [μm]		—	$\sigma \leq 0,8$	—	$\sigma \leq 0,8$	—	$\sigma \leq 0,8$	—	$\sigma \leq 0,8$	—	$\sigma \leq 0,8$	—	$\sigma \leq 0,8$
Temperature compensation function		Automatic											

The other specifications are the same as those of QVTP APEX Pro.

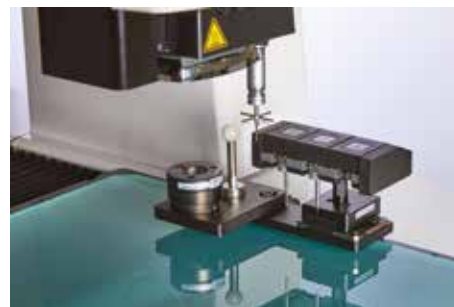

QVH4 Pro

Non-contact Displacement Sensor-equipped CNC Vision Measuring System



- This dual system with a non-contact displacement sensor has a scanning function that enables measurement of minute height differences and 3D shapes.
- The non-contact displacement sensor (CPS probe) uses the wavelength confocal method.
- The LED used as the light source of the displacement sensor has an auto-brightness control function that enables seamless measurement of materials with different reflectivity.

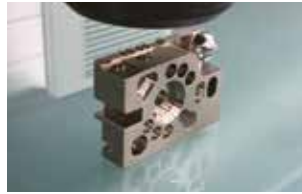

QVH4 HYPER 606 Pro

Model		QVH4 APEX 302 Pro	QVH4 APEX 404 Pro	QVH4 APEX 606 Pro
Order No.		365-601 QVH4A-X302P1L-E	365-611 QVH4A-X404P1L-E	365-621 QVH4A-X606P1L-E
Main unit	Size, mass			
Measuring range [mm]	Vision	300×200×200	400×400×250	600×650×250
	Common to vision non-contact displacement sensor	176×200×200	276×400×250	476×650×250
Observation unit*1		Programmable power turret 1X-2X-6X		
Illumination unit	Contour illumination	White LED		
	Surface illumination	White LED		
	PRL	White LED		
Resolution of scale [μm]		0,1		
Vision measuring accuracy [μm]	$E_{UX} / E_{UY, MPE}$	(1,5 + 3L/1000)		
	$E_{UXY, MPE}$	(2,0 + 4L/1000)		
	$E_{UZ, MPE}$	(1,5 + 4L/1000)		
Displacement sensor measuring accuracy [μm]*2	E_{IZ}	(1,5 + 4L/1000)		
Temperature compensation function		Manual		

*1 Programmable power turret 1X-2X-4X model and 1X-2X-4X-6X model are available to special order. *2 Determined by Mitutoyo's inspection method.

Model		QVH4 HYPER 302 Pro	QVH4 HYPER 404 Pro	QVH4 HYPER 606 Pro
Order No.		365-605 QVH4A-H302P1L-E	365-615 QVH4A-H404P1L-E	365-625 QVH4A-H606P1L-E
Resolution of scale [μm]		0,02		
Vision measuring accuracy [μm]	$E_{UX} / E_{UY, MPE}$	(0,8 + 2L/1000)		
	$E_{UXY, MPE}$	(1,4 + 3L/1000)		
	$E_{UZ, MPE}$	(1,5 + 2L/1000)		
Displacement sensor measuring accuracy [μm]*	E_{IZ}	(1,5 + 2L/1000)		
Temperature compensation function		Automatic		

The other specifications are the same as those of QVH4 APEX Pro.
* Determined by Mitutoyo's inspection method.

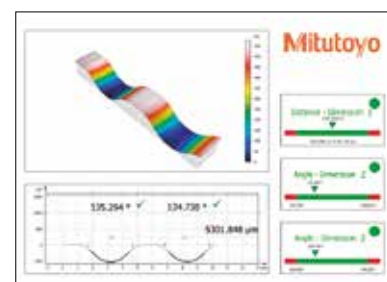
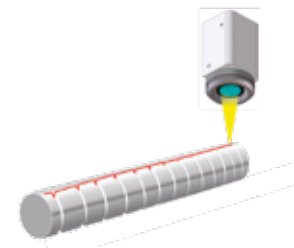
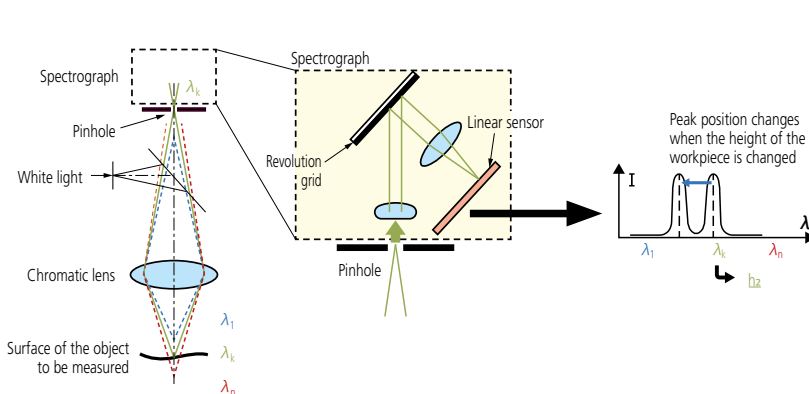

QV HYBRID TYPE1

Non-contact Displacement Sensor-equipped CNC Vision Measuring System



- This dual system with a non-contact displacement sensor has a scanning function that enables measurement of minute height differences and 3D shapes.
- The double-pinhole technique is used as the detection method of the displacement sensor. It is less directional compared with the knife-edge and triangulation techniques.
- The small laser spot with a diameter of about 2 μm makes it possible to measure minute shapes.

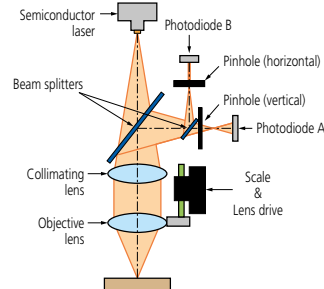
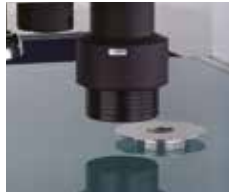

QV Hybrid Type1 Apex 404

Model	QVH1 302		QVH1 404		QVH1 606		
	Apex						
Standard	QVH1-X302P1L-D		QVH1-X404P1L-D		QVH1-X606P1L-D		
Measuring range [mm]	Vision	300x200x200	400x400x250	600x650x250	Same as Apex		
	Common to vision displacement sensor	180x200x200	280x400x250	480x650x250	Same as Apex		
Observation unit*1	Programmable power turret 1X-2X-6X						
Illumination unit	Contour illumination	White LED					
	Surface illumination	White LED					
	PRL	White LED					
Resolution of scale [μm]	0,1				0,02		
Vision measuring accuracy [μm]*2	E _{ix} , E _{iy}	(1,5 + 3L/1000)				(0,8 + 2L/1000)	
	E _{iz}	(1,5 + 4L/1000)				(1,5 + 2L/1000)	
	E _{zxy}	(2,0 + 4L/1000)				(1,4 + 3L/1000)	
Displacement sensor measuring accuracy [μm]	E _{iz}	(1,5 + 4L/1000)				(1,5 + 2L/1000)	

*1 Programmable power turret 1X-2X-4X model and 1X-2X-4X-6X model are available to special order. *2 Determined by Mitutoyo's inspection method.

Hyper QVWLI

Non-contact 3D Measuring System



- Hyper QVWLI is a high-accuracy dual 3D measurement system consisting of QV and a white light interferometer.
- You can perform 3D surface texture analysis and 3D roughness analysis from 3D data captured by the WLI optical system.
- You can also perform dimension measurement and cross-section measurement at a specific height using the 3D data.

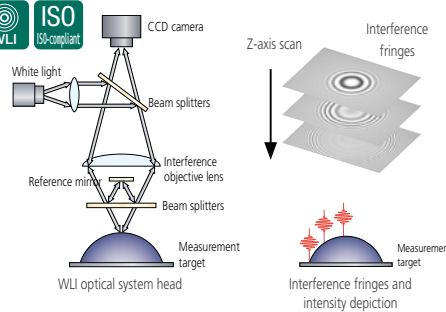

Hyper QVWLI 606

Model	Hyper QVWLI 302		Hyper QVWLI 404		Hyper QVWLI 606		
	QVW-H302P1L-D						
Standard	QVW-H302P1L-D		QVW-H404P1L-D		QVW-H606P1L-D		
Measuring range [mm]	Vision measurement	300x200x190	400x400x240	600x650x220	Same as Apex		
	WLI measurement	215x200x190	315x400x240	515x650x220	Same as Apex		
Observation unit*1	Programmable power turret 1X-2X-6X						
Illumination unit	Contour illumination	White LED					
	Surface illumination	White LED					
	PRL	White LED					
	WLI optical head	Halogen					
Resolution of scale [μm]	0,01						
Vision measuring accuracy [μm]*2	E _{ix} , E _{iy}	(0,8 + 2L/1000)				(0,8 + 2L/1000)	
	E _{iz}	(1,5 + 2L/1000)				(1,5 + 2L/1000)	
	E _{zxy}	(1,4 + 3L/1000)				(1,4 + 3L/1000)	
	Accuracy guaranteed with optics specified	2.5X objective (QV-HR2,5X or QV-SL2,5X) and middle magnification tube lens					
WLI Z-axis scanning range (max.)	QVWLI A-5X, QVWLI A-10X: 6,3 mm, QVWLI A-25X: 3,2 mm, QVWLI A-50X: 1,0 mm						
WLI Z-axis repeatability [μm]*2	2σ ≤ 0,08						

*1 Programmable power turret 1X-2X-4X model and 1X-2X-4X-6X model are available to special order. *2 Determined by Mitutoyo's inspection method.

QV ACCEL

CNC Vision Measuring System



- This is a vision measuring machine with moving-bridge type main unit structure suitable for measuring large objects.
- As the stage is fixed on the moving-bridge structure, you can use a simple method to fixture a workpiece, which is suitable for measuring small, thin objects.
- QV ACCEL 1212 (range: 1250×1250×100 mm) and QV ACCEL 1517 (range: 1500×1750×100 mm) are available to special order.



QV ACCEL 808

Model	QV ACCEL 808		QV ACCEL 1010
Standard	QV-A808P1L-D		QV-A1010P1L-D
Measuring range [mm]	800×800×150		1000×1000×150
Observation unit*1	Programmable power turret 1X-2X-6X		
Illumination unit	Contour illumination	White LED	
	Surface illumination	White LED	
	PRL	White LED	
Resolution of scale [μm]	0.1		
Vision measuring accuracy [μm]*2	E _{1X} , E _{1Y}	(1.5 + 3L/1000)	
	E _{1Z}	(1.5 + 4L/1000)	
	E _{2XY}	(2.5 + 4L/1000)	
Repeatability [μm]*2	Short dimension	X, Y axis	3σ ≤ 0.2
	Long dimension		3σ ≤ 0.7

*1 Programmable power turret 1X-2X-4X model and 1X-2X-4X-6X model are available to special order.

*2 Determined by Mitutoyo's inspection method. Short dimension = Repeatability within a single screen; Long dimension = Repeatability over several screen movements.

ULTRA QV

Ultra-high Accuracy CNC Vision Measuring System



- Ultra-high accuracy CNC vision measuring machine with measuring accuracy of E_{1XY} (0,25 + L/1000) μm.
- Our proprietary high-resolution (0.01 μm) and high-accuracy low-expansion glass scales are used on the X, Y and Z axes.
- The main unit utilizes a highly rigid moving Y-axis table with a fixed bridge. The base is made of high-stability granite.



ULTRA QV 404

Model	ULTRA QV 404		
Standard	QV-U404P1N-D		QV-U404T1N-D
Measuring range [mm]	400×400×200		
Observation unit*1	Programmable power turret 1X-2X-6X		
TAF	—		✓
Illumination unit	Contour illumination	Halogen	
	Surface illumination	Halogen	
	PRL	Halogen	
Resolution of scale [μm]	0,01		
Vision measuring accuracy [μm]*2	E _{1X} , E _{1Y}	(0,25 + L/1000)	
	E _{1Z} (50 mm stroke)	(1,0 + 2L/1000)	
	E _{1Z} (Full stroke)	(1,5 + 2L/1000)	
	E _{2XY}	(0,5 + 2L/1000)	
LAF Repeatability [μm]	—		σ ≤ 0,8

*1 Programmable power turret 1X-2X-4X model and 1X-2X-4X-6X model are available to special order. *2 Determined by Mitutoyo's inspection method.

OPTIONS



QV Objectives

Objective	QV-SL0.5X*	QV-HR1X	QV-SL1X	QV-HR2.5X	QV-SL2.5X	QV-HR5X	QV-5X	QV-HR10X*	QV-10X*	QV-25X*
Order No.	02AKT199	02AKT250	02ALA150	02AKT300	02ALA170	02AWD010	02ALA420	02AKT650	02ALG010	02ALG020
Set of objectives that support PFF	—	—	—	02AKX895B	—	02AXA915B	02AKX900B	02AKX905B	—	02AKX910B
Working distance [mm]	30,5	40,6	52,5	40,6	60,0	20,0	33,5	20,0	30,5	13,0
Field of view (H)×(V) mm	Turret 1X	12,54×9,4	6,27×4,7	2,49×1,86	1,24×0,93	0,62×0,47	0,25×0,18	0,12×0,09	0,10×0,07	0,04×0,03
	Turret 2X	6,27×4,7	3,13×2,35	1,24×0,93	0,62×0,47	0,31×0,23	0,25×0,18	0,20×0,15	0,12×0,09	0,10×0,07
	Turret 6X	2,09×1,56	1,04×0,78	0,41×0,31	0,20×0,15	0,10×0,07	0,04×0,03	0,04×0,03	0,04×0,03	0,04×0,03

* When the QV-SL0.5X, QV-HR10X, QV-10X, or QV-25X objective is used, some limitations, such as the illumination being insufficient depending on the workpiece, may occur.

Monitor magnification*1	15X	29X	58X	72X	87X	144X	173X	290X	430X	580X	720X	870X	1440X	1730X	4300X
Field of view [mm]	12,54×9,40	6,27×4,70	3,13×2,35	2,49×1,86	2,09×1,56	1,24×0,93	1,04×0,78	0,62×0,47	0,41×0,31	0,31×0,23	0,25×0,18	0,20×0,15	0,12×0,09	0,10×0,07	0,04×0,03
0.5X objective	●	●			●										
1X objective		●	●			●									
2.5X objective				●			●								
5X objective						●		●							
10X objective*2								●	●						
25X objective*2										●	●				

*1 The monitor magnification is a reference value when an image is displayed at 1X screen magnification on a 22-inch wide LCD monitor. QVPAK version 10 or later supports changing of video window size.

*2 When using a 10X or 25X objective lens in conjunction with a 2X or 6X power turret, brightness illumination may be insufficient depending on the workpiece.

Calibration Chart and QV Compensation Chart

Calibration chart

A calibration chart is used to compensate for the pixel size of the camera imaging chip and for the autofocus accuracy and optical axis offset at each magnification of the variable magnification unit (PPT).



QV compensation chart

This glass chart is used to perform compensation for distortions within the screen caused by the optical system, and autofocus compensation, which reduces autofocus variations that are caused by differences between the workpiece pattern and texture.



Note: There are limitations on the function, depending on the lens. For details, contact your Mitutoyo sales office.

SOFTWARE

Application software that offers both functionality and operability

In addition to high-performance vision measuring functions, we offer a wide range of software applications such as shape analysis using a non-contact displacement sensor and the automatic creation of measurement programs. From simple to complex measurements, our lineup can resolve any measurement issues that our customers may encounter.

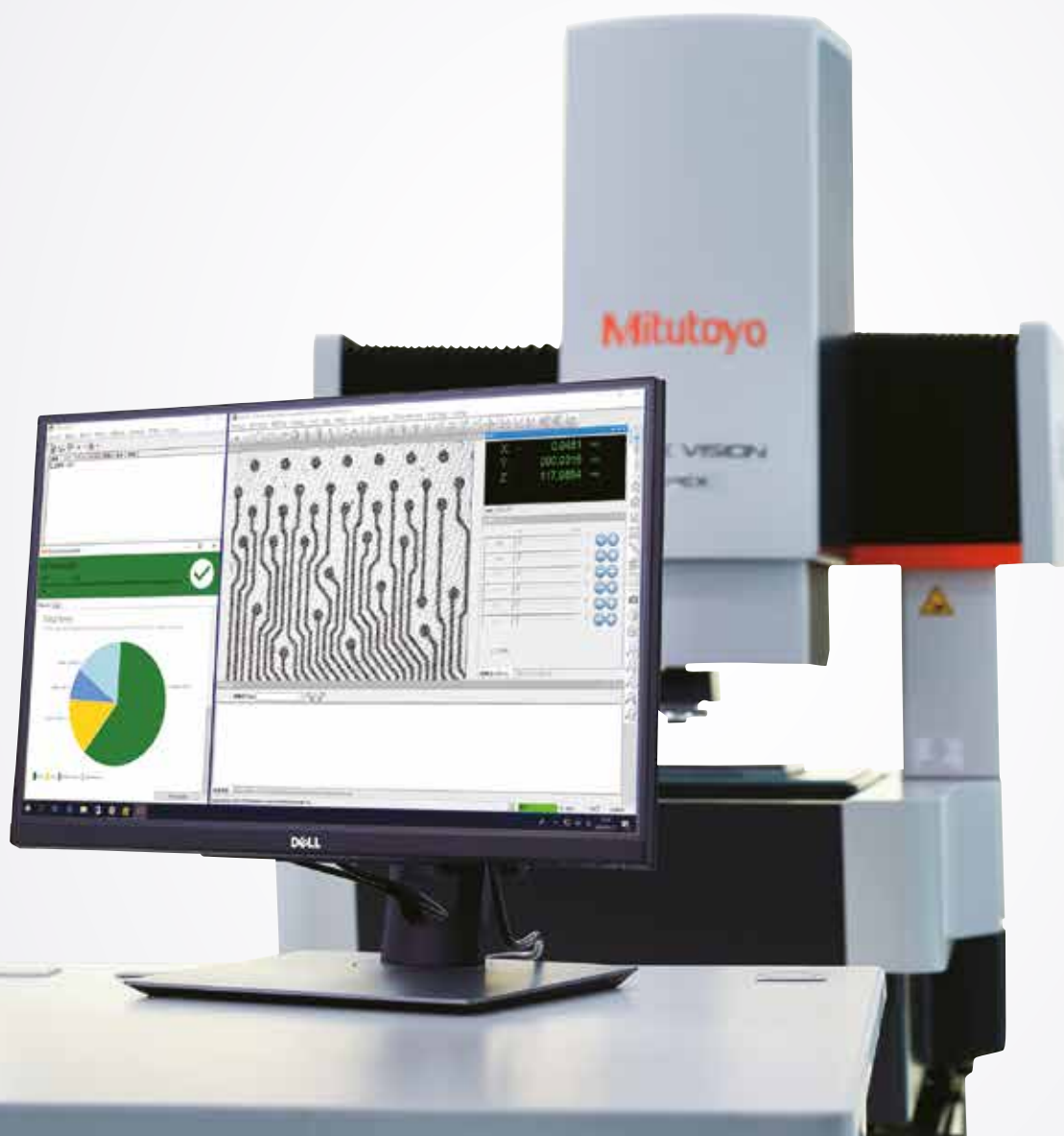

A rich choice of measuring functions

1 One-click Tool

Whatever your proficiency level, this function enables you to perform high-accuracy measurements by simply selecting the measurement item (circle, line, etc.) and clicking the edge to measure. The outlier removal function automatically removes traces of burrs and contaminants.

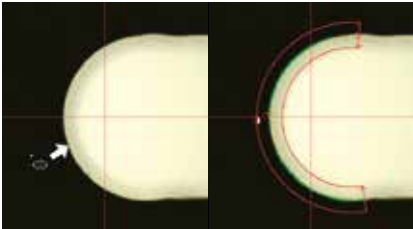

2 AI Illumination Tools

There are two tools: the dual area contrast tool, which can adjust the light intensity to the optimal value at procedure creation time, and the brightness tool, which automatically compensates for the light intensity at program creation time. These tools stabilize the light intensity during repeat measurements, which increases edge detection repeatability and reduces the occurrence of edge detection errors caused by light intensity fluctuations.

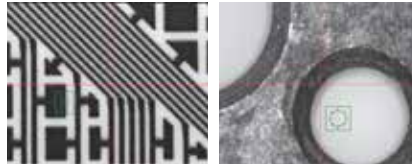

Dual Area Contrast Tool

Brightness Tool

3 Multi-point Autofocus

You can subdivide an autofocus tool or set up multiple autofocus tools at desired sizes, positions, and angles.

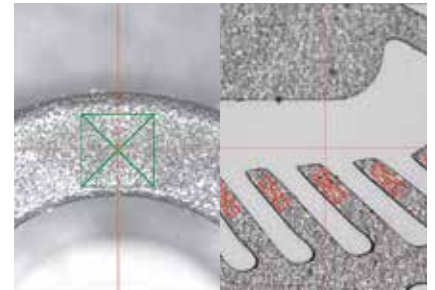

4 QV Graphics NEW

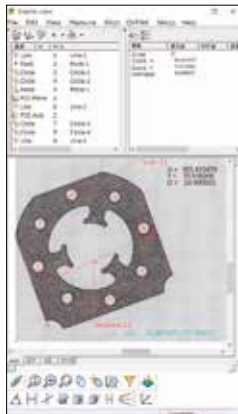

Not only can this feature be used for reports of measurement results, but also high-level calculations, such as calculations between elements and PCD measurements can be performed by selecting diagrams with the mouse.

In addition, effective use of the graphics function makes it possible to easily edit part programs and is also useful in checking the coordinate system of the current workpiece and in checking for any forgotten measurements.

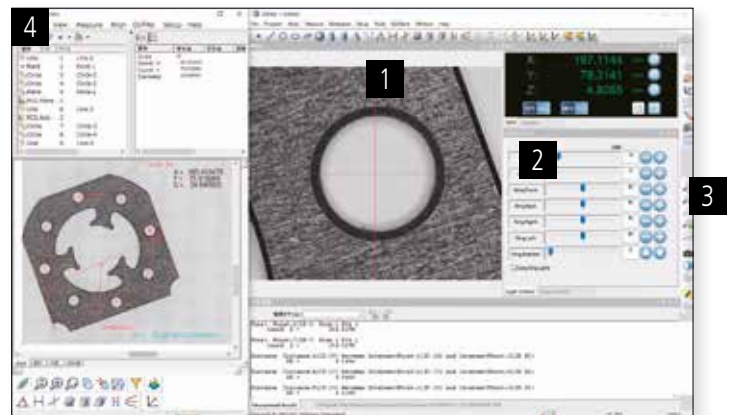

5 QV EasyEditor

QV EasyEditor records and allows you to easily edit the details of the operator's measuring process. The program list displays error icons for you to quickly find the parts to correct.

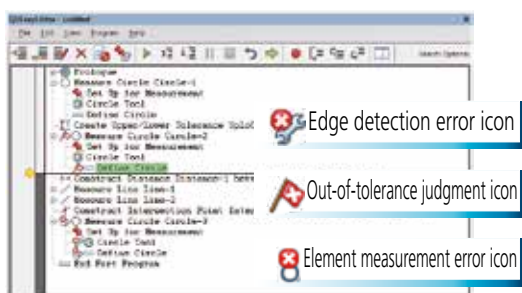

6 MiCAT Reporter NEW

MiCAT Reporter is equipped as standard with the purpose to create reports from the QVPAK measurement results. The software can output data into PDF directly, allowing you to create medical component reports and other reports requiring reliability.



OPTIONAL SOFTWARE

FORMTRACEPAK-AP

Form Evaluation and Analysis Software

FORMTRACEPAK-AP performs tolerancing and form analysis from data obtained with the QV's auto trace tool, non-contact displacement sensor, WLI, and PFF.

Contour Tolerancing Function

- Design data creation
 - CAD data conversion, master workpiece conversion, function specification, text file conversion, and aspherical surface design value creation
- Tolerancing
 - Normal vector direction tolerancing, axial direction tolerancing, and best-fit tolerancing

Microscopic Form Analysis

- Analyzed items: point measurement, line measurement, circle measurement, distance measurement, intersection measurement, angle measurement, origin setting, and axial rotation
- Calculated items: maximum, minimum, average, standard deviation, and area

Report Creation Function

- Measurement result, error graph, and error developed view

Other Functions

- Recording and executing analysis procedures
- External output function:
 - CSV, text, or DXF/IGES format output

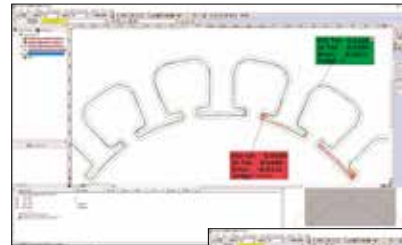

Tolerancing example

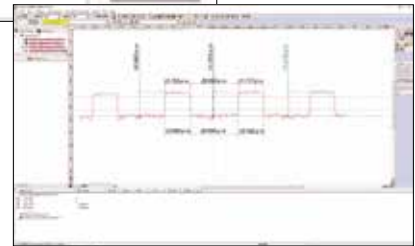

Example of using WLI to perform line, space, and conductor thickness measurements on a printed circuit board

MCubeMap

3D Surface Property Analyzing Software

3D data captured by WLI can be analyzed according to parameters compliant with ISO25178-6: 2010, including Sa, Sq, and other height parameters as well as 3D roughness parameters related to space, complexity, and functionality.

You can also analyze 2D shapes and measure volumes from the 3D data captured by PFF or QV Hybrid.

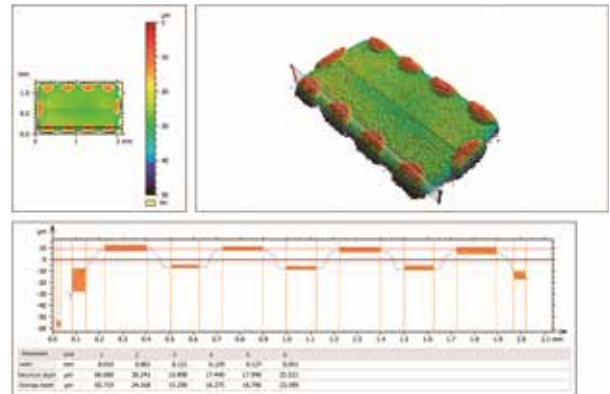

Example of SMD terminal height measurement by PFF

FORMTRACEPAK-PRO

Form Evaluation and Analysis Software

3D data captured by WLI can be analyzed for 3D surface roughness and surface texture. You can also analyze the displayed 3D shape information captured by the non-contact displacement sensor of PFF or QV Hybrid.

Main Functions

- 3D display
 - Wireframe, shading, contour line, contour line filling
- Trend compensation and filter processing
 - Trend compensation using flat surfaces, spherical surfaces, cylindrical surfaces, and polyhedrons
 - 1D and 2D digital filters for each profile
- Digitization of a rich variety of surface textures
 - Relative load curves and area distribution curves can be used to evaluate wear and oil accumulation areas.
 - Spectral analysis, cutoff area and volume analysis, angle of inclination calculations at peaks and valleys, and histogram calculations of numbers of valleys can be performed.
- Function for extracting features from measurement data
 - Extraction of a chosen cross-section, slope enhancement, and simultaneous analysis of the peaks and valleys of the cutoff surface can be performed.

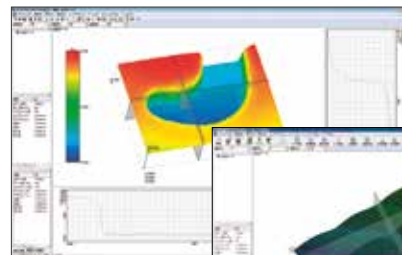

Example of using PFF to measure a molded component

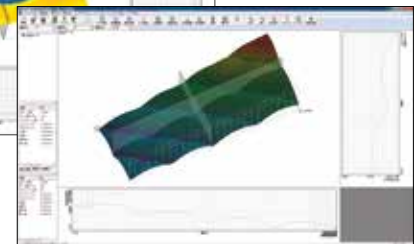

Example of using CPS to perform acrylic lens array measurements

EASYPAG-PRO

Offline Teaching Software

DXF IGES GERBER data

EASYPAG-PRO can use 2D CAD model to create QVPAK part programs offline. This reduces the number of man-hours required to create part programs, which results in a decrease in programming time.

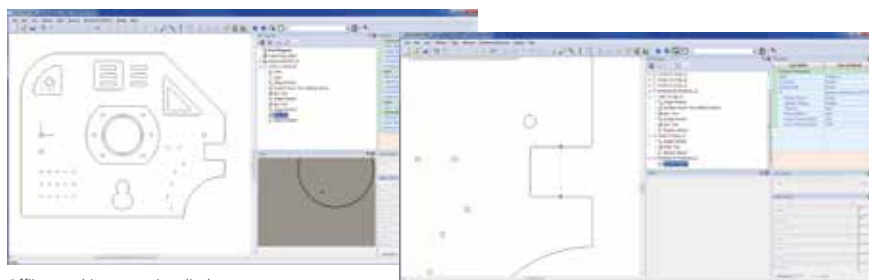

Offline teaching operation display

Line-to-arbitrary point distance measurement

QV3DCAD

QV3DCAD creates a QVPAK part program from a 3D CAD model. The current version supports two modes: the online mode that allows you to teach while monitoring the actual workpiece by synchronizing the software with the QV system, and the offline mode that allows you to create a part program on a PC not connected to the main unit.

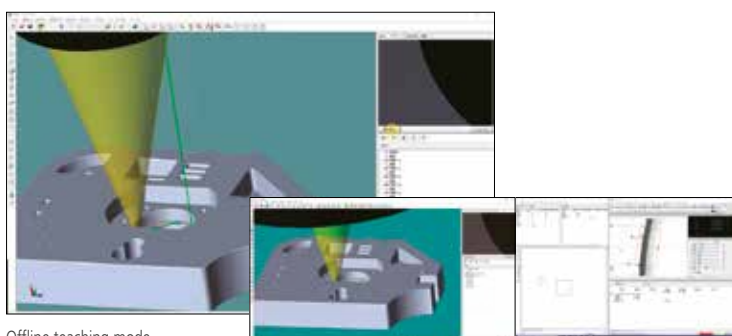

Offline teaching mode

Online teaching mode

MSURF-I

Compares the 3D data captured by CPS, laser, WLI, and PFF with the design data of the 3D CAD model, etc.

Note: A separate PC is necessary for MSURF-I analysis.

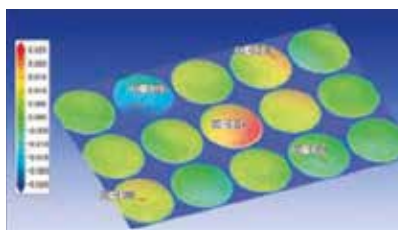

QV3DPAK

QV3DPAK is a software application that composes 3D forms from PFF (Point From Focus) or WLI (White Light Interferometer) data.



SMART FACTORY

From Status Management to Preventative Maintenance Kickstart Your Smart Factory Through Visualization

Mitutoyo has developed new features that use a network to centrally manage manufacturing process information. The MeasurLink® software package helps prevent defective parts by collecting and analyzing measurement data in real-time. The status monitor (SMS: Smart Measuring System) shows the operating status of the measuring machine and helps improve productivity.



QVEio

IO application making the smart factory real

QVEio-PLC supported example

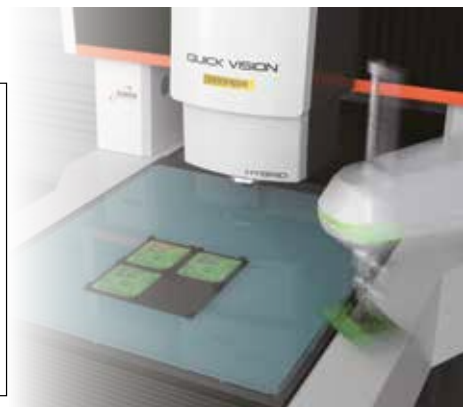
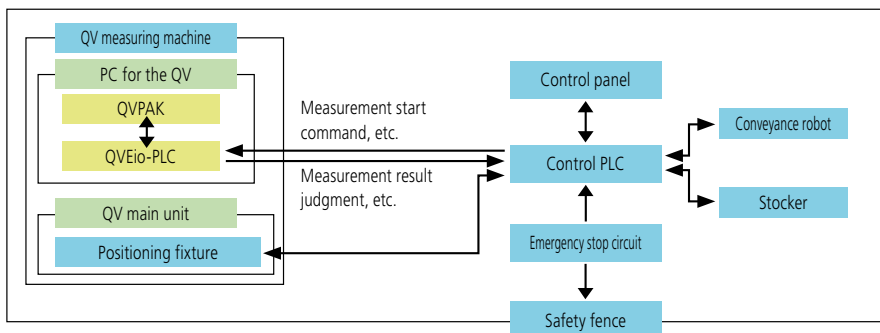



Status Monitor

Can remotely monitor measuring machines



MeasurLink®

Reduces defective products by visualizing quality

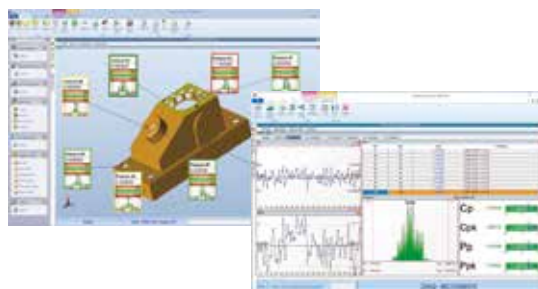

Note: MeasurLink® is a registered trademark of Mitutoyo Corporation in Japan and Mitutoyo America Corporation in the United States.

INSPECTION

"DDPAK-QV" - software for the QUICK VISION Series that enables both flaw inspection and high-accuracy measurement

DDPAK-QV is a flaw inspection software for QUICK VISION.

Utilized during measurement to inspect for flaws, such as contaminants, burrs, and cracks while performing high-accuracy non-contact measurement at the same time.

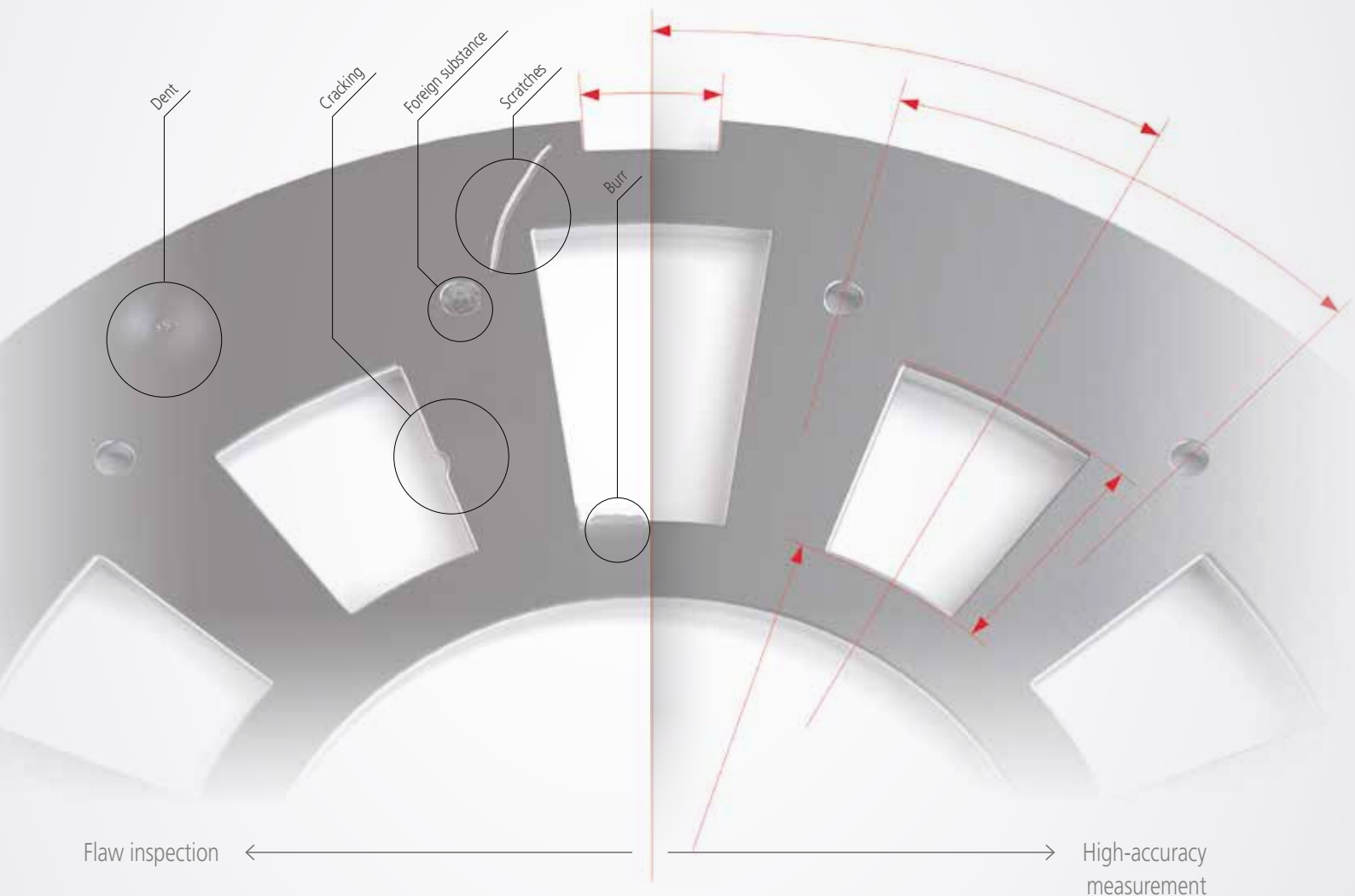

DDPAK-QV

Flaw Inspection Software dedicated for CNC Vision Measuring System QUICK VISION

Features

- Creates a seamless flaw inspection system that transfers the image data captured by the QUICK VISION Series to DDPK-QV, outputs the flaw coordinates and automatically saves the image.
- Measures the dimensions of a flaw and analyzes its shape. Analyzing the coordinate, size, depth, height, and other statistics of a flaw can help analyze the cause, prevent the recurrence, and improve the production process.
- You can add DDPK-QV, the flaw inspection software, to your QUICK VISION. Add the inspection feature to expand the applications of your QUICK VISION.

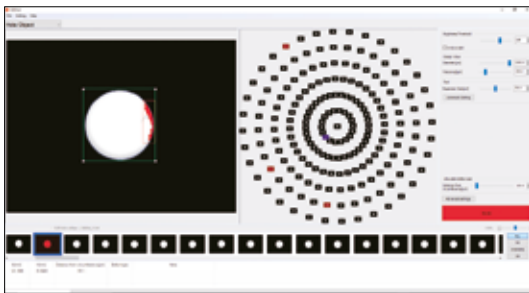

Inspection for foreign substances in shower head diameters



The image of the detected flaw turns red



Chipped blade

Flaw detection example

Chip on glass



Cracked glass

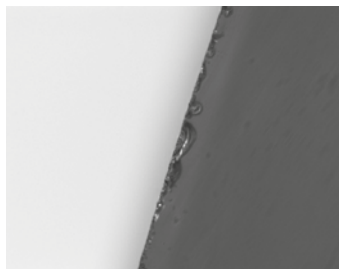

Print blurring on an electronic part

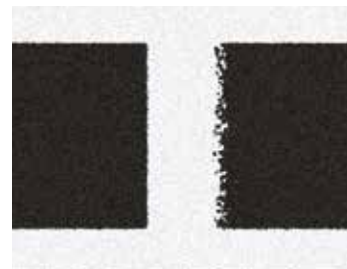

Foreign substance in a hole

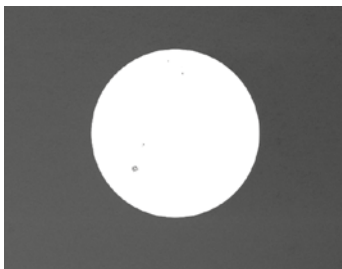

Scratched mirror-finished surface



Note: DDPK-QV is available to special order. For details on supported workpieces and flaws, contact your local Mitutoyo sales office.



Mitutoyo supports you from start to finish.

Mitutoyo is not only a manufacturer of top-quality measuring products but one that also offers qualified support for the lifetime of the equipment backed up by comprehensive services, ensuring your staff can make the very best use of the investment.

Apart from the basics of calibration and repair, Mitutoyo offers product and metrology training, as well as IT support for the sophisticated software used in modern measuring technology. We can also design, build, test, and deliver bespoke measuring solutions and even, if deemed cost-effective, take your critical measurement challenges in-house on a sub-contract basis

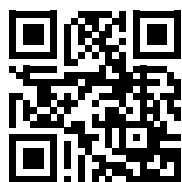

Find additional product literature and our complete catalog here.

www.mitutoyo.eu

Note: MITUTOYO is either registered trademarks or trademarks of Mitutoyo Corp. in Japan and/or other countries/regions. Other product, company and brand names mentioned herein are for identification purposes only and may be the trademarks of their respective holders. Product illustrations are without obligation. Product descriptions, in particular any and all technical specifications, are only binding when explicitly agreed upon.

Mitutoyo

Mitutoyo Europe GmbH

Borsigstraße 8-10
 41469 Neuss
 Tel. +49 (0) 2137-102-0
info@mitutoyo.eu
www.mitutoyo.eu